

# MANUAL

## Synchronising device KSY 3xx



## Content

1	General Remarks.....	6
2	Safety Information.....	7
3	Measurement.....	7
3.1	Voltage Measurement.....	7
3.2	Frequency Measurement.....	7
3.3	3-phased mains (with or without Neutral Conductor).....	8
3.4	1-phased Grids.....	8
3.5	Behaviour at low Voltages.....	8
4	Installation.....	8
4.1	Mechanical Installation.....	8
4.2	Electrical Installation.....	8
4.2.1	Connection Diagram.....	9
4.3	Commissioning.....	9
4.3.1	Basic Settings.....	9
5	Operation.....	10
5.1	Overview of the Control Elements.....	10
5.1.1	Buttons.....	11
5.1.2	DIL Switches.....	11
5.1.3	LEDs.....	12
5.1.4	Graphic Display.....	12
5.1.5	USB Interface / Driver Install.....	12
5.2	Display View.....	13
5.2.1	Main Screen.....	13
5.2.2	Synchronisation.....	13
5.2.3	Menu Structure.....	14
5.2.3.1	Actual fault.....	16
5.2.3.2	Measuring Values.....	17
5.2.3.3	Fault Messages.....	18
5.2.3.4	Info.....	19
6	Configuration of the Device.....	19
6.1	Converter Settings.....	19
6.2	Nominal Values of the Plant.....	20
6.3	Display Format.....	20
6.4	Configuration via KuPa010.....	20
6.5	Configuration at the Device.....	20
6.5.1	Protection of Input with PIN.....	21
6.6	Parameter Setting.....	21
6.6.1	Selection of Groups and Parameters.....	22
6.6.2	Entering of a Value.....	23
6.6.3	Setting the Fault Message Coding.....	24
6.7	Setting of Time and Date.....	25
6.7.1	Via KuPa010.....	25
6.7.2	Manually Setting of Time.....	26
6.8	Language Selection and Switching.....	26
7	Operation.....	27
7.1	Operating Principle.....	27
7.2	Parallel Switching Points (PSP).....	27
7.3	Operating Modes.....	28

7.3.1	Mains parallel Mode.....	28
7.3.2	Synchronisation Mode .....	28
7.3.3	Isolated operation Mode .....	28
7.4	Synchronisation .....	29
7.4.1	Synchronisation clearance.....	29
7.4.2	Syn Pulse .....	29
7.4.3	Switching-on clearance.....	29
7.4.3.1	Switching-on Voltage .....	30
7.4.3.2	Switching-on Frequency .....	30
7.4.4	Monitoring Functions .....	30
7.4.4.1	Clearance Monitoring.....	30
7.4.4.2	Monitoring of Synchronisation Pulse.....	30
7.4.4.3	Delta-f Clearance.....	31
7.4.5	Isolated Operation .....	31
7.5	Usage as Locking Relay .....	31
7.6	Switching onto Dead Bus-Bar .....	32
7.7	Synchronisation Pulse as permanent Contact.....	33
7.8	Limit Values .....	33
7.8.1	Behaviour of the Limit Values .....	33
7.8.2	Triggering of Limit Values .....	33
7.8.3	Manually / Automatically Reset.....	34
7.8.4	Disable limit values .....	34
7.8.5	Central Fault .....	35
7.8.6	Central Fault 1+2 .....	35
7.8.7	Display First Error .....	35
7.8.8	SYN-preventing Limit Value.....	35
7.8.9	Operating Mode depended Release (only generator Limit Values) .....	36
7.9	Limit Value Settings .....	36
7.9.1	Rotary Field Monitoring (Mains and/or Generator) .....	36
7.9.2	Monitoring of Angle Error (Mains and/or Generator) .....	37
7.9.3	Voltage Triggering – Under-/Overvoltage (Mains and/or Generator) .....	37
7.9.4	Voltage Asymmetry Triggering (Mains and/or Generator) .....	38
7.9.5	Deviation of Voltage Mean Value (Mains and/or Generator) .....	38
7.9.6	Frequency Triggering Under-/Overfrequency (Mains and/or Generator) .....	39
7.9.7	Vector Shift Triggering (Mains) .....	39
7.9.8	Delta f to Delta t (ROCOF) (Mains) .....	40
7.9.9	Slip .....	40
7.10	Trigger Memory .....	40
7.10.1	Reading out the Trigger Memory .....	41
7.11	Programmable Switching Points .....	41
8	PID-T1 Controller.....	43
8.1	Controller Ramps.....	43
8.2	Dead Zone.....	43
8.3	Clearance Delay .....	43
8.4	Controller Parameters.....	44
9	Pulse Controller .....	44
9.1	PFM (Pulse Frequency Modulation).....	45
9.1.1	Controller Parameters .....	45
9.2	PWM (Pulse Width Modulation) .....	45
9.2.1	Controller Parameters.....	46
9.3	Dead Zone.....	46

9.4	Release Delay .....	46
10	Electronic Potentiometer .....	47
10.1	Parameters .....	47
11	Inputs.....	48
11.1	Digital Inputs .....	48
11.1.1	Monitoring of the Relay- (Contactor-) Acknowledgement .....	50
12	Outputs.....	50
12.1	Digital Outputs .....	50
12.2	Analogue Outputs (optionally).....	57
13	Logic Functions.....	59
13.1	Output Logic Function on Digital Input Function.....	59
13.2	AND – Gate (1) .....	60
13.3	OR – Gate (2) .....	60
13.4	Exclusive OR – Gate (3) .....	60
13.5	AND-Not – Gate (4) .....	60
13.6	OR-Not – Gate (5) .....	60
13.7	Exclusive Not-OR – Gate (6).....	60
13.8	Timer pick up delayed.....	61
13.9	Timer drop down delayed .....	61
13.10	Fault Message Assignment.....	61
13.11	Locking Functions and Auto Reset.....	61
14	Technical Data.....	62
14.1	Triggering Values.....	63
14.2	Ordering Information .....	63
15	Connection Diagram .....	64
16	Parameter Groups .....	65
16.1	Configuration (Konfig. / Config – Group 1) .....	65
16.2	Limit Values (Grenzwerte / Limits – Group 4).....	67
16.3	Analogue Outputs.....	70
16.4	Digital Outputs (Digi. Ausg. / OUT – Group 6).....	70
16.5	Digital Inputs (Digi. Eing. / IN – Group 7) .....	71
16.6	Logic Functions (Logik – Group 10) .....	72
16.7	Syn (SYN – Group 11) .....	74
16.8	PID-T1-, Pulse Controller and Electronic Potentiometers (Regler – Group 12).....	78

## Amendments

Date	Amendment	Name
17-12-04	Creation	Halbauer, Twesten

## 1 General Remarks

The synchroniser relay KSY 3xx adjusts voltage and frequency of a generator to the mains, in order to connect it to the mains at a minimum of frequency and voltage deviation, and with identical phasing. Depending on its configuration, the SYN-7 is monitoring sense of rotation, voltage difference and asymmetry.

Voltage measurement is done as 2-, 3- or 4- (3 + N) conductors measurement, according to the respectively preset parameterisation. Frequency measurement is basically carried out on L1 and L2. In isolated operation, the desired frequency and voltage are internally set by the device.

The KSY 3xx allows the interconnection of up to four parallel switching points. Separate parameters can be set for each switching point.

The KSY 3xx enfold the following functions [according to ANSI/IEEE C37.2]:

- Overspeed Device/Protection [12]
- Synchronous-Speed Device [13]
- Underspeed Device [14]
- Synchronizing or synchronism-check device [25]
- Undervoltage [27]
- Overvoltage [59]
- Monitoring of frequency [81]
- Controller (voltage / frequency) [90]

For parameterisation of the KSY 3xx it is recommended to use of the supplied parameterisation software KuPa010, which is also available on our website [www.kuhse.de](http://www.kuhse.de) (download of the current version).



Depending on the version of the used parameterisation software KuPa010 the used images of this document may differ from the actually appearance within the software.

## 2 Safety Information



The following safety and installation instructions must be observed when handling the device:

Installation and commissioning only by trained professionals.

The user is responsible for checking the correct configuration of the KSY 3xx before commissioning or maintaining the device.

Maximum values given in this description must not be exceeded.

The device must be disconnected from the mains during maintenance and installation.

Symbols shown in this description have the following meaning:

	The Caution symbol indicates possible injury or life hazards.
	Explanatory text or hint on special features at the handling or behaviour of the device.

## 3 Measurement

### 3.1 Voltage Measurement

The voltage measurement is a true root mean square value measurement. It operates up to a neutral point voltage lower limit of approximately 10 V (L-N). As soon as a measuring voltage is detected, the LED of the respective phase lights up. The KSY 3xx can be deployed in mains of 57/100 V up to 230/400 V. The accuracy of the voltage measurement is better than 0.2 % of the end value (280/480 V).

The six string voltages are measured simultaneously with 32 samples per period.



As long as no frequency is measured, the sampling of the voltage measurement operates with the adjusted nominal frequency.

### 3.2 Frequency Measurement

The frequencies of the three grid voltages as well as the frequencies of two generator voltages are recorded and evaluated separately. The frequency measurement begins with a phase voltage of approx. 10 V. The accuracy at absolute values is better than 0.01 Hz.

### 3.3 3-phased mains (with or without Neutral Conductor)

Measuring with or without neutral point may be selected by the choice of the measurement method. At measuring without neutral point, it is not necessary to connect a neutral conductor. Due to a special internal wiring of the terminals, in a 3-wire + N – system the loss of the neutral conductor can be detected and indicated in form of a voltage asymmetry or undervoltage Lx.

### 3.4 1-phased Grids

If the KSY 3xx is set to 2-conductor operation, the measurement and monitoring is only carried out between L1 and N. The limit values for angle error, rotary field monitoring, mean value and asymmetry are internally deactivated, vector shift must be adjusted.

### 3.5 Behaviour at low Voltages

Below a measuring voltage of approx. 20 V, the accuracy of the voltage measurement and the angle measurement decreases. The measuring voltage lower limit is reached at approx. 10 V. Then for frequency and voltage 0 is displayed.

## 4 Installation



Assembly and commissioning only by trained professionals,  
Connection in compliance with VDE 0160.

### 4.1 Mechanical Installation

The KSY 3xx is designated for a mounting on a 35 mm top-hat rail, according to DIN EN 60715. The installation width is approx. 100 mm.

### 4.2 Electrical Installation



**Assembly and commissioning only by trained professionals.**  
**Selecting the cables and the electrical connection of the device, the regulations of the VDE 0100 "Regulations for the Setting up of Power Installations with nominal Values below 1000 V", VDE "Equipment of Power Installations with Electrical Components" resp. the respective national / local regulations must be observed.**

**The electrical connection has to be carried out only by trained professional staff (VDE 1000 T. 10).**

**The device must be disconnected from the mains during maintenance and installation work.**



## 4.2.1 Connection Diagram

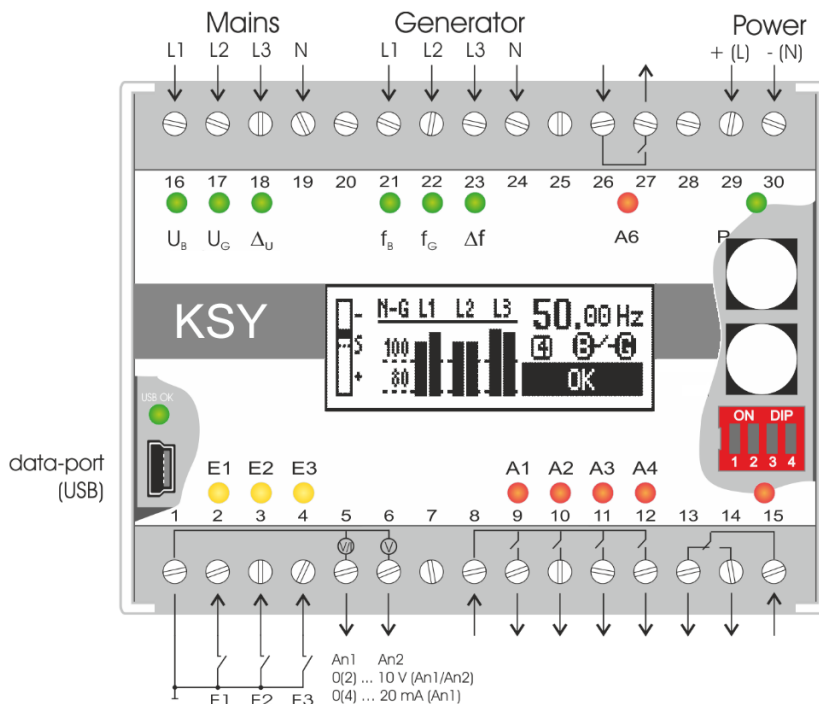

## 4.3 Commissioning

For putting the KSY 3xx into operation, it is to connect as per connection diagram (see chap. 4.2.1). In the following, parameterisation must be done. The device is calibrated at the factory and pre-set with factory settings.

### 4.3.1 Basic Settings

On commissioning, the settings of the converter ratios for voltage as well as the nominal voltages are to adapt in compliance with the plant parameters.

At the first start-up, settings must be made to adapt the KSY 3xx to the respective plant. This includes the nominal voltage according to the plant parameters as well as the converter ratios for the voltage measurement. The settings can be done by the supplied, respectively for downloading on our homepage available parameterisation software KuPa010, alternatively inputs are possible directly at the device (see chap.0 -

Configuration at the Device).

The procedure for parameter input on the device is described in detail in chapter 6 - Configuration of the Device.

## 5 Operation

### 5.1 Overview of the Control Elements

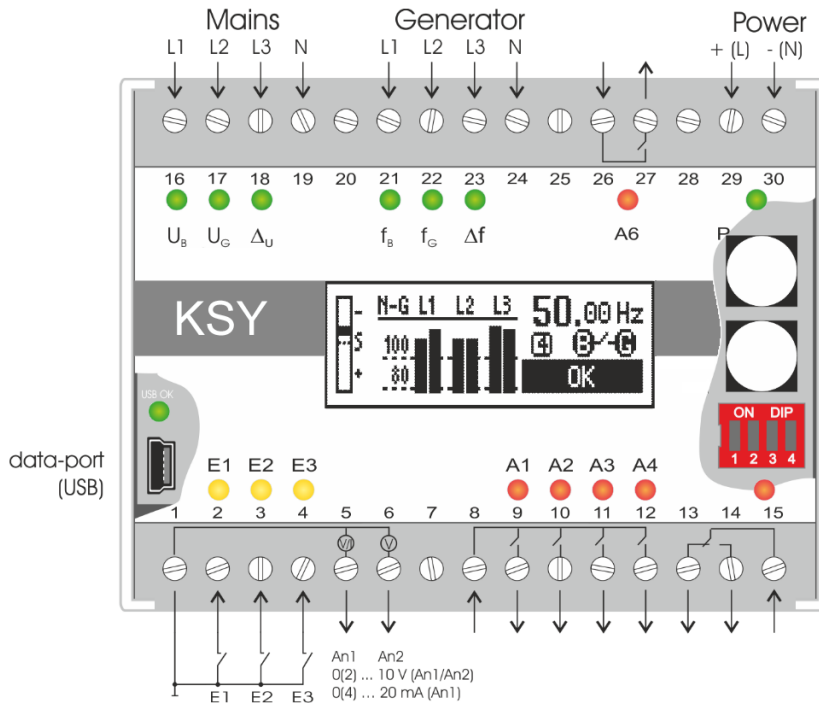

The control elements, DIL switches and communication interface (USB interface) are only accessible, when the front lid of the KSY 3xx is removed. It is unconditional to avoid to touch other than the here listed elements. After completion of the intended activities, the cover must be replaced.

### 5.1.1 Buttons

For direct access to the operation of the device, the KSY 3xx has two buttons (*figured below*). In connection with the DIL switch (see *chap. 5.1.2*) and the graphic display, almost all relevant settings can be performed directly at the device. The following functions are assigned to the buttons:

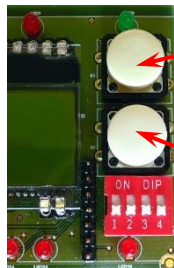

UP Button  
(UP)

UP button

Scrolling through various menus

Enter Button  
(ENT)

Increasing of values in the parameter setting  
(see *chap. 5.2 - Display View*)

Deleting of stored trigger values (see *chap 7.10 - Trigger Memory*)

Enter button

Enter a menu item

Exit a (sub-)menu item (press & hold 2s)

Confirming an entry

In operation: scrolling through the various main screens

In main screen: performing a limit value reset  
(press & hold 2s, see *chap. 7.8.3*)



The functions of the KSY 3xx buttons listed above are not to be seen as a complete list of all functions. Further details and notes on functions of the buttons of the KSY 3xx are described in the respective chapter of this document, which refers to the operation of the device by means of the buttons.

### 5.1.2 DIL Switches

The DIL Switches have the following functions:

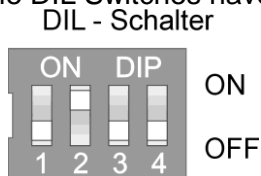

S1:	OFF	automatic fault message reset acc. to parameterisation
	ON	STM auto reset disabled; reset by digital input or reset button (press & hold Enter button 2s)
S2:	ON	editing of parameters
S3:	ON	language switching
S4:	ON	enforce delta-f clearance
S2 + S4:	ON	setting the device clock

### 5.1.3 LEDs

The LEDs have the following functions:

**LED U<sub>B</sub>:**

The LED is on (green), when voltage is detected at all configured phases of the mains.

**LED U<sub>G</sub>:**

The LED is on (green), when voltage is detected at all configured phases of the generator.

**LED ΔU:**

The LED is on (green), when the difference of voltage between mains and generator ranges within the set limit values at released synchronisation.

**LED f<sub>B</sub>:**

The LED is on (green), when frequency is detected at all configured phases of the mains.

**LED f<sub>G</sub>:**

The LED is on (green), when frequency is detected at all configured phases of the generator.

**LED Δf:**

The LED is on (green), when the frequency between mains and generator ranges within the set limit values at released synchronisation.

**LED E1 ... E3:**

The LEDs represent the corresponding digital input. If the input is activated (bridged to KL 1), the associated LED is on (yellow). The parameterization of the input after quiescent or working current is irrelevant here.

**LED A1 ... A6:**

The LEDs represent the corresponding relay output. If the relay output is activated (relay energised), the associated LED is on (red). The parameterization of the input after quiescent or working current is irrelevant here.

### 5.1.4 Graphic Display



The device status is output via a backlit graphic display with a resolution of 132 x 32 pixels. In connection with the DIL switches and the Buttons almost all relevant settings can be performed directly at the device. All relevant (measuring-) data are as well shown on the graphic display.

### 5.1.5 USB Interface / Driver Install

The KSY 3xx is equipped with an USB interface (mini-USB), which allows parameterisation of the device. To ensure the correct function, the USB driver file 'lpc\_driver\_setup.exe' must be installed before the first use (file can be found on the delivery included installation medium as well as, after installation of the KuPa010, in the program folder of KuPa010). PCs with the operating system Windows XP or later are supported.

Connect the KSY 3xx to the designated PC system using an USB cable (parameterisation cable USB A : USB Mini B) and switch on the auxiliary voltage of the KSY 3xx.

After successful completion of the installation process, the interface 'LPC USB VComPort' should be listed in the Windows device manager (figured right). The parameterisation software KuPa010 now can be used with the KSY 3xx.

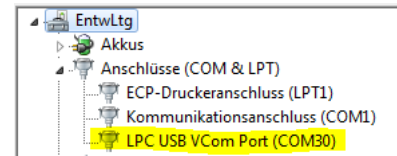

During regular operation the USB cable should be disconnected.

## 5.2 Display View

### 5.2.1 Main Screen

The main screen shows all relevant measured values and messages.

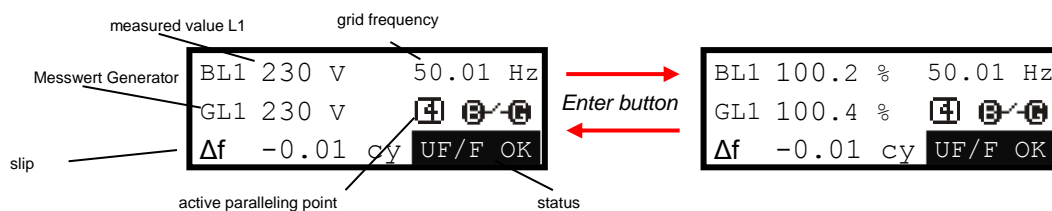

The various views can be changed by use of the Enter button.

Pressing the UP button, the menu will be entered.

### 5.2.2 Synchronisation

With the beginning synchronisation, the main screen of the changes automatically into the hereby relevant display view.

The upper axis shows above the voltage difference  $dU$  and below the frequency  $df$ . The arrow shows the respective largest deviation (L1, L2 oder L3). The two inner marking lines characterise the maximum permissible deviation,  $\Delta U_{max}$  and  $\Delta f_{max}$ , of the respective selected parallel switching point. The axis is scaled according to the set limit values.

The lower axis shows the phase angle between  $U_B$  and  $U_G$  (mains and generator).

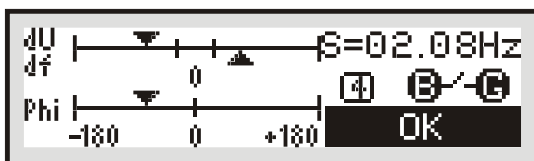

### 5.2.3 Menu Structure

The menu can be called up from the main screen using the UP button. Pressing the Enter button then activates the respective submenu.

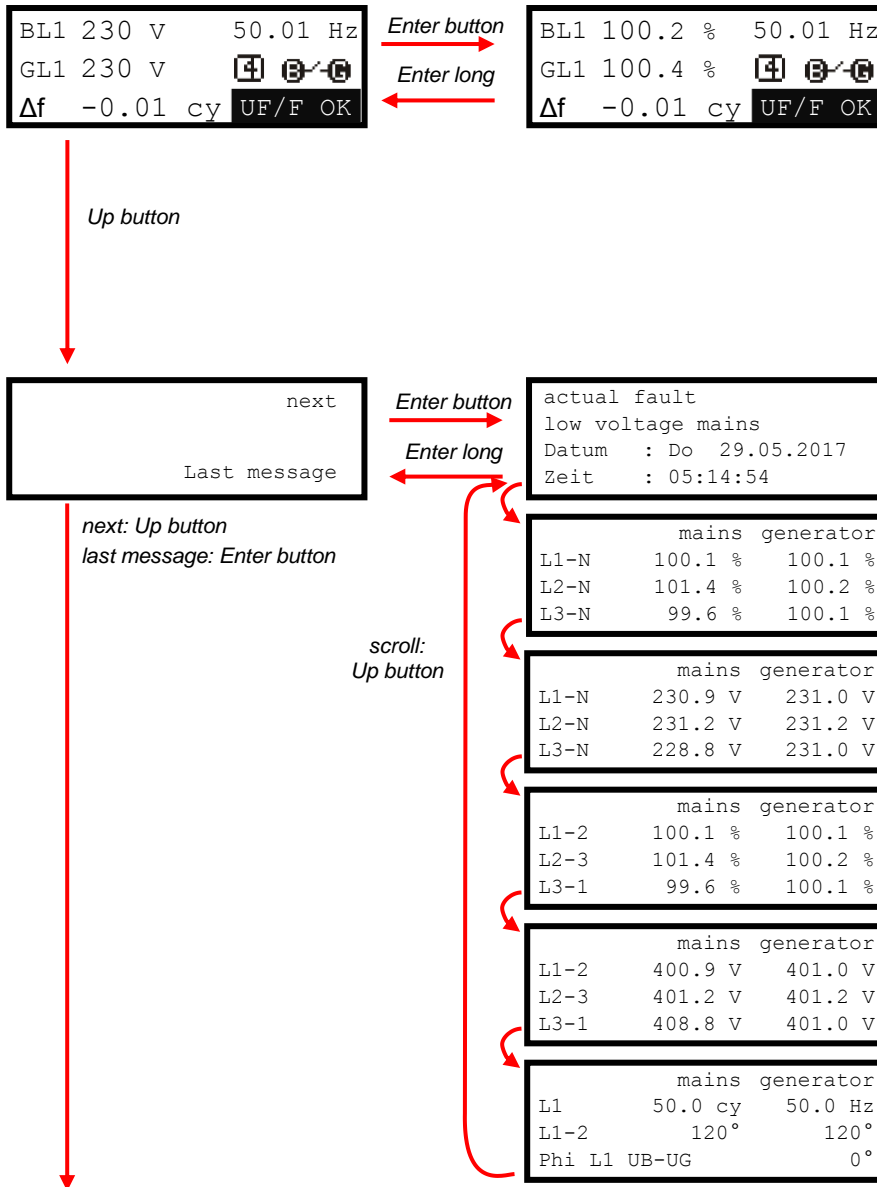

(Onwards at the next page)

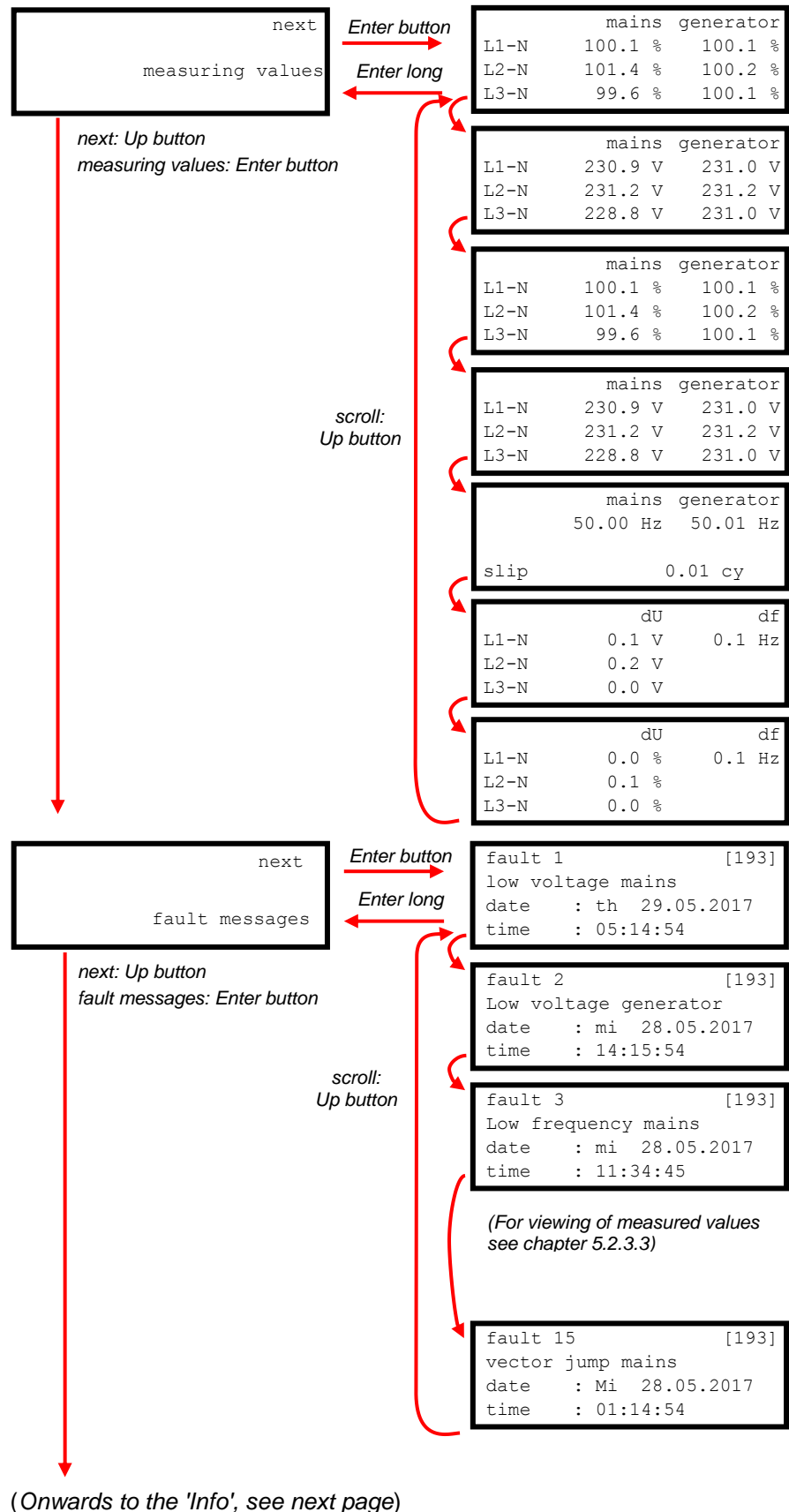

(Onwards to display in operating mode, see previous page)

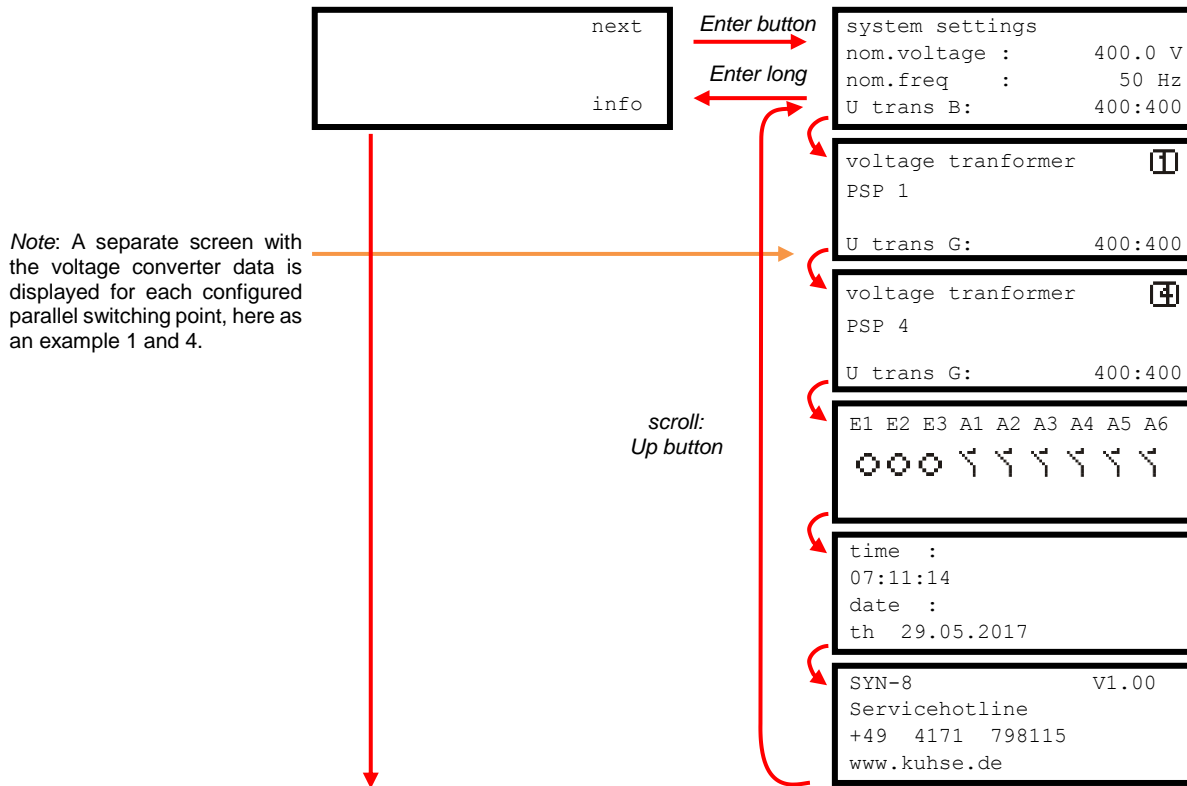

### 5.2.3.1 Actual fault

The last stored message is shown within the menu 'actual fault' – regardless of whether it is still pending. All measuring values available at the time of the message are retrievable. The UP button can be used to scroll through the measuring values listed below, which were present at the time of the message. Actuating the Enter button switches back to the selection menu.

Type and time of the last message

- Neutral point voltages of mains and generator absolute and relative
- Conductor voltages of mains and generator absolute and relative
- Frequencies of mains and generator
- Voltage difference mains – generator
- Frequency difference mains – generator



### 5.2.3.2 Measuring Values

The current measured values are displayed in the menu 'Measuring Values' as described in the following. By means of the parameterisation, the display ranges can be pre-selected or can be set as automatic (factory setting: 0) range switching (see *chap. 6.3*).

Scrolling is done using the Up button. Actuating the Enter button switches back to the selection menu.

The following measuring values can be displayed:

- Neutral point voltage of all 3 phases absolute and relative
- Conductor voltage of all 3 Phases absolute and relative
- Frequencies of mains and generator
- Slip (frequency difference mains – generator)
- Voltage differences mains – generator absolute and relative

### 5.2.3.3 Fault Messages

The last stored messages, regardless of whether these are still pending, are displayed in the 'fault messages' screen. All measured values, which are existing at the time of the respective message, are retrievable. Scrolling through the releases is done with the UP button. Actuating the Enter button changes into the display of individual stored releases. With the Up button one can scroll through the values contained here in. With a long time press (>2s) at the Enter button the display switches back to the previous level.

Type and time of triggering

- Neutral point voltages of grid and generator absolute and relative
- Conector voltages of grid and generator absolute and relative
- Frequencies of grid and generator
- Voltage difference mains – generator
- Frequency difference mains – generator

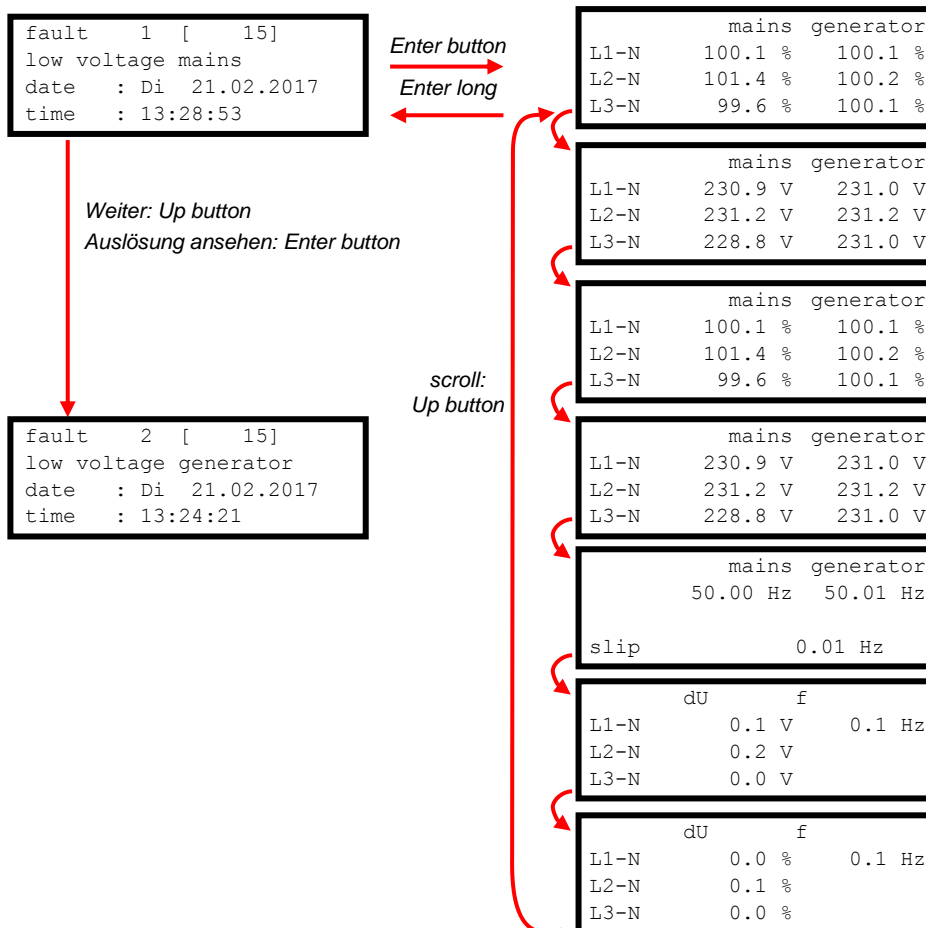

### 5.2.3.4 Info

In the 'Info' screen, important and service information is displayed:

- Nominal values of the plant
- Setting of the voltage converters
- State of the digital in- and outputs
- Date and time (also setting)
- Firmware- and service information

## 6 Configuration of the Device

For a correct adjustment to each individual application, the parameterisation of the device is required. For parameterisation the use of the supplied, respectively for downloading on our Homepage [www.kuhse.de](http://www.kuhse.de) available parameterisation software KuPa010 is recommended. The modification of the most operating settings by direct input at the device is possible as well.

At the first start-up, some settings have to be made in order to adapt the KSY 3xx to the respective plant. This includes: nominal voltage, nominal frequency, kind of mains and voltage transformer ratios. If these parameters are not correctly adjusted to the plant, the KSY 3xx will not work properly.

### 6.1 Converter Settings

The converter ratio for the voltage transformers is specified in the KuPa010 (*figured right*) or directly at the device in the ratio of primary voltage to secondary voltage.

A separate value for the converter secondary voltage of the parallel switching point must be set for each parallel switching point. The primary voltage refers to parallel switching point 1 at all parallel switching points.

The screenshot displays the configuration interface for the KSY 3xx device, organized into three main sections:

- voltage transformer**:
  - mains**: Includes a schematic diagram of a transformer with primary terminals K, L, N and secondary terminals k, SYN, I. Primary voltage is set to 400 V and secondary voltage is set to 400 V.
  - generator**: Includes a schematic diagram of a generator with primary terminals K, L, N and secondary terminals k, SYN, I. Primary voltage is set to 400 V and secondary voltage is set to 400 V.
- parallel switching points**:
  - count**: A dropdown menu is set to "4 parallel switching poi". Below it is a schematic showing four parallel switching points, each with a generator symbol (G).
  - transformer secondary**: Three input fields for PSP 2, PSP 3, and PSP 4, each set to 400 V.

## 6.2 Nominal Values of the Plant

The plant nominal values are also entered via KuPa010 or directly at the device.



*At 3-wire grid form, the nominal voltage is related to the outer conductor voltage.*

*At 3-wire + N grid form, the nominal voltage is related to the string voltage.*

## 6.3 Display Format

The selection of the respective display area depends on the configuration of the plant. Nominal Voltage and setting of the voltage converters must be adapted before commissioning. The measurement range selection is preset to automatically by factory defaults.

The following display areas are provided:

Value	Voltage U
0	automatically
1	0 ... 999.9 V
2	0 ... 9999 V
3	0 ... 99.99 kV
4	0 ... 999.9 kV
5	0 ... 999 kV

## 6.4 Configuration via KuPa010

Values and settings, which are stored on the KSY 3xx can be read out at any time from the device with a PC system by means of the parameterisation software KuPa010. The data can be stored on the PC and printed out for documentation purposes.

## 6.5 Configuration at the Device

The setting of most values is also possible directly at the device. The menu for editing the parameters is called up in operating mode (see chap. 0), while the main screen is shown in the device display - by closing the DIL switch S2 (see chap.5.1.2). The procedure for the input at the device is described in detail below. The parameter data listed in the section parameter groups (see chap. 0) must be observed.

### 6.5.1 Protection of Input with PIN

The editing at the device can be protected by a four-digit user defined PIN. With activated PIN protection, an input at the device is only possible, after entering the correct PIN.

The PIN is entered digit by digit from right to left (see also chap. 6.6.2). Using the UP button the respective digit is incremented, with the Enter button the entry of the number will be confirmed and to cursor moves to the next position. If the last digit of the PIN is entered correctly, the display changes into the 'Parameter Setting' menu (see chap. 6.6). If the PIN is entered incorrect, the input line is reset to 0000. The input can be repeated, starting at the last digit (figured above).

```
system protected
please input PIN
PIN : 0000
```

The PIN protection can be set via KuPa010 or via the parameter setting at the device (see chap. 16.1).



After the PIN has been successfully entered, the input protection is automatically activated again, if no key has been pressed for more than 10 minutes.

## 6.6 Parameter Setting

If the DIL switch S2 is closed (ON), the device display changes to the parameter setting. To exit the parameterisation, the DIL switch S2 must be opened (OFF) again. If the parameterisation is exited without correctly completing of a begun input, the newly set value gets lost and the previous setting remains active. Set values are stored permanently in the flash module of the device. The values are retained even at loss of the voltage supply, a battery based buffering is not required.

The setting values are arranged in parameter groups (see chap. 0). Each group contains a number of setting values and, where appropriate, further properties. The following groups are available:

- Configuration (Konfig. / Config)
- Limit values (Grenzwerte / Limits)
- Analogue output (Analog. Ausg. / OUT)
- Digital output (Digi. Ausg. / OUT)
- Digital input (Digi. Eing. / IN)
- Logic (Logik)
- Synchronisation (SYN)
- Controller parameters (Regler)
- Group 1
- Group 4
- Group 5
- Group 6
- Group 7
- Group 10
- Group 11
- Group 12

### 6.6.1 Selection of Groups and Parameters

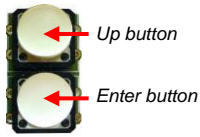

In parameter setting mode (DIL switch S2 closed, input protection PIN inactive) the device display shows the selection of the parameter group (*parameter groups see chap. 0*). Using the Up button (*see chap. 0*) the respective parameter group, which is intended to be edited, can now be selected now.

By actuating the Enter button, the display changes into the menu of the selected group. The subgroup with its parameters to be edited (*see chap. 0*) can be selected herein by means of the scroll function of the Up button (*see chap. 0* -



Buttons). Shown in the example (*figured below*): Switching from parameter subgroup 6.1.x (Digital Output A1) to 6.2.x (Digital Output A2).

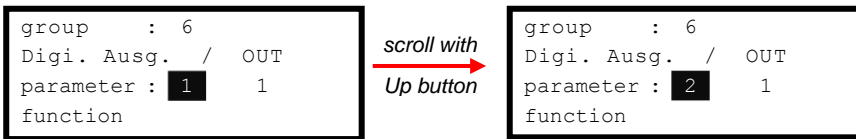

The selected subgroup is now called up with the Enter button. The parameter to be changed can be selected in this menu item using the Up button. Shown in the example (*figured below*): Switching from parameter 6.2.1 (Function A2) to parameter 6.2.2 (Switching behaviour A2 – refer to chap. 12.1 - Digital Outputs).

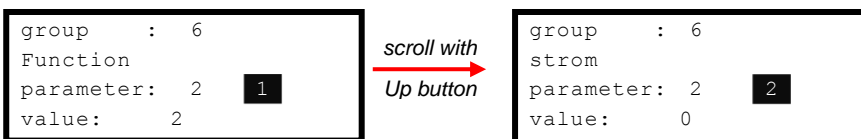

Press the Enter key to call up the menu for the editing of the parameter to be changed. After the entry has been made and the change is confirmed (*see chap. 6.6.2*), the display returns to the menu of the current parameter subgroup.

To move from one menu level to the next higher, that is from the subgroup to the parameter group and from the parameter group ) to the group selection, the enter key must be pressed for approx. 1.5 seconds (*figured below*).

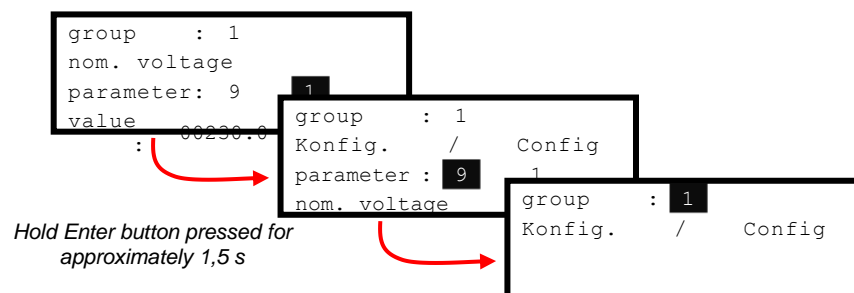

## 6.6.2 Entering of a Value

After selecting the parameter group and -subgroup, as well as the selection of the parameter value, the editing of the value is initiated by pressing the Enter button again. The cursor is at the last position of the value to be edited (*figured right below*).

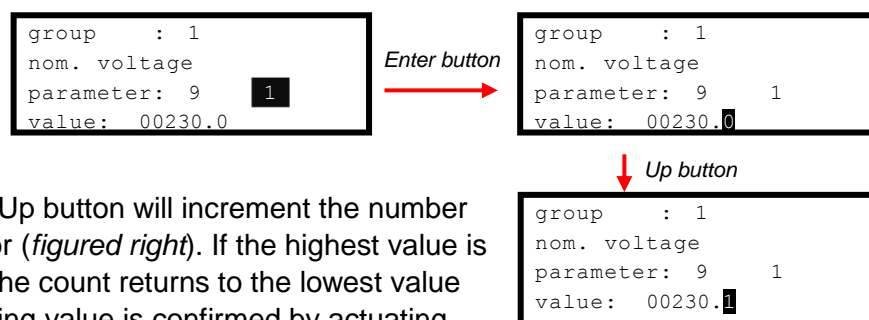

Repeatedly pressing the Up button will increment the number activated under the cursor (*figured right*). If the highest value is reached in this position, the count returns to the lowest value (9 → 0). The desired setting value is confirmed by actuating the Enter button. The cursor moves to the next digit.

This operation is repeated for all digits of the current value to be changed.

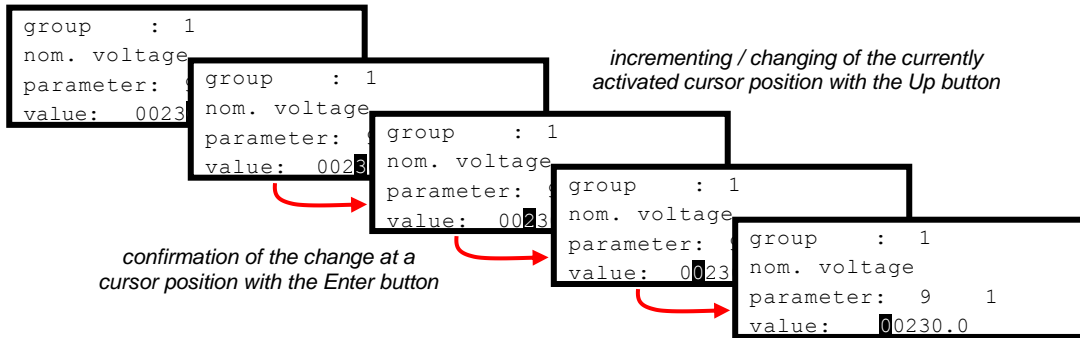

When the last digit (left position) of the value to be changed has been edited and confirmed with the Enter key, a safety query occurs, with which the change of the parameter value must be confirmed. Using the Up button, the current change can be discarded here. The previous setting is retained. Actuating the Enter button (ENT), the entry of the parameter value is accepted and stored in the flash memory of the KSY 3xx. The value is valid immediately after confirmation.

```
value changed  
cancel with UP  
save with ENT
```



### 6.6.3 Setting the Fault Message Coding

The setting of the fault message behaviour is performed bit by bit for the respective limit values. With the selection of parameter 6.x.6 the value in the bottom line of the display is switched to binary number (*figured right*).

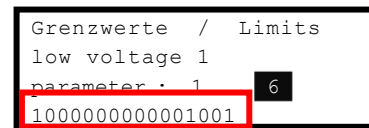

The bit positions 1, 4, 5, 6, 7, 8, 13, 14, 15 and 16 are adjustable:

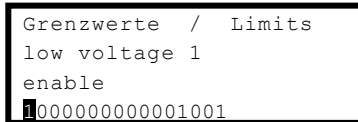

Bit position 1 / enable:  
The triggering of the fault message for the respective limit value is activated (1) / not activated (0).

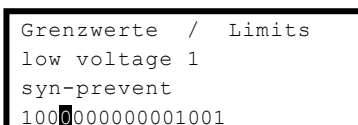

Bit position 4 / SYN-preventing  
Synchronisation is prevented, if a limit value that is parameterised by this option is triggered.

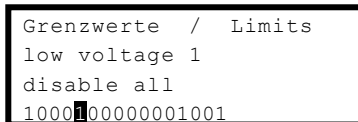

Bit position 5 / disable all (*only Logic Table [10]*):  
The respective limit value can be disabled (1) for the triggering by means of the 'disable all' function .

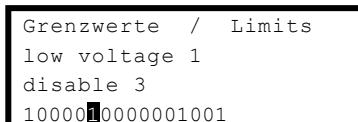

Bit position 6 / disable 3:  
The respective limit value can be disabled (1) for the triggering by means of the 'disable 3' function.

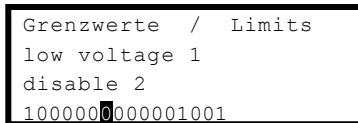

Bit position 7 / disable 2:  
The respective limit value can be disabled (1) for the triggering by means of the 'disable 2' function.

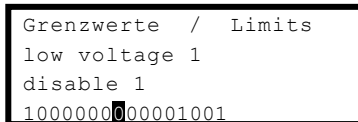

Bit position 8 / disable 1:  
The respective limit value can be disabled (1) for the triggering by means of the 'disable 1' function.

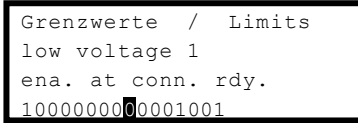

Bit position 9 / enable at connection-readiness:  
The respective limit value only is active, if readiness for switching on predominates.

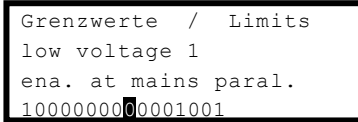

Bit position 10 / enable at mains parallel:  
The respective limit value only is active, if the operating type mains parallel mode predominates.

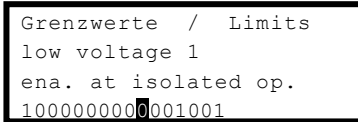

Bit position 11 / enable at isolated operation:  
The respective limit value only is active, if the operating type isolated operation predominates.

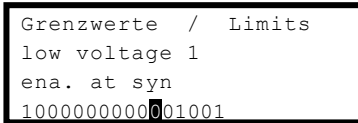

Bit position 12 / enable at SYN mode:  
The respective limit value only is active, if the operating type SYN predominates.

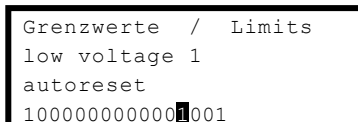

Bit position 13 / Auto reset:  
The auto reset (*see chap. 7.8.3*) is enabled (1) / disabled (0) for the respective limit value.

```
Grenzwerte / Limits
low voltage 1
central fault 2
1000000000001001
```

Bit position 14 / central Fault Message 2:  
The fault message triggering for the limit value is additionally - not (0) / carried out (1) under ' Central Fault Message 2' (see chap. 7.8.6)

```
Grenzwerte / Limits
low voltage 1
central fault 1
1000000000001001
```

Bit position 15 / central Fault Message 1:  
The fault message triggering for the limit value is additionally - not (0) / carried out (1) under ' Central Fault Message 1' (see chap. 7.8.6)

```
Grenzwerte / Limits
low voltage 1
central fault
1000000000001000
```

Bit position 16 / central Fault Message  
*(only Logic Table [10]):*  
The fault message triggering for the limit value is - not (0) / carried out (0) under ' Central Fault Message' (see chap. 7.8.5).

## 6.7 Setting of Time and Date

The real-time clock integrated in the KSY 3xx operates in 24h format and continues to run for at least 72 hours in case of auxiliary power supply failure. Date and time of the KSY 3xx can be adjusted in different ways.

Using the parameterisation software KuPa010.

Manually at the device.

### 6.7.1 Via KuPa010

Time and Date are adjustable via KuPa010. On this, the time of the used PC system is applied.

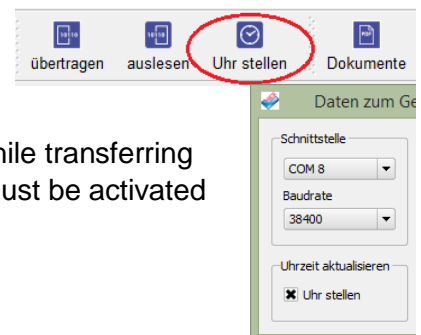

The clock of the KSY 3xx can be set by clicking on 'set clock', or while transferring or reading out the configuration. For this, the option 'adjust clock' must be activated during transmission.

## 6.7.2 Manually Setting of Time

The setting of date and time is called up at the device by closing of the DIL switches S2 and S4. Actuating the Enter button, the editing is activated.

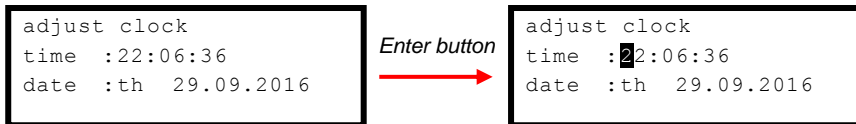

Using the Up button now the activated digit is altered. The made setting is confirmed by actuating the Enter button, the cursor changes to the next position of the input area (*figured below – refer chap. 6.6.2 - Entering of a Value*).

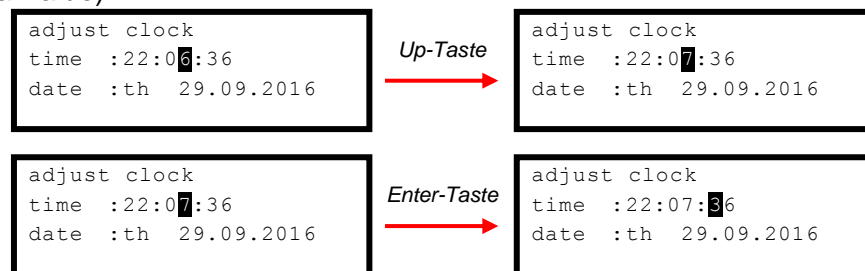

The procedure described above must be repeated for all positions of the time and date input.



The day of the week cannot be set manually. The day of the week is set automatically on the base of the set date

## 6.8 Language Selection and Switching

Basically the display texts are available at the device in 2 languages. The factory default is German and English. Other languages can be set up at the customer's request and thus made available on the device display by means of the parameterisation software.



Using the device parameterisation it is determined which language is the main language, and whether it is allowed to switch between the languages. The following options are adjustable:

- only language 1 (German)
- only language 2 (English)
- language 1 or language 2 (German / English)
- language 2 or language 1 (English / German)

The switching between the two display languages can alternatively be carried out via the parameterisation software, DIL switch S3 or a parameterised input. If DIL switch S3 or the assigned input is closed, the language is switched according to the parameterization, if the changeover is permitted.

## 7 Operation

### 7.1 Operating Principle

The Synchroniser Relay KSY 3xx captures the voltage and frequency of two (separate) alternating current grids. The measurement can be configured either for 2-, 3- or 4- conductors systems. If controlling is approved (SYN-clearance, factory setting E1), the KSY 3xx controls the generator voltage and the generator frequency via analogue outputs (PID-T1 controller) as well as pulse controllers (pulse frequency modulated or pulse width modulated, depending on the configuration). The target point of the control is adjustable.

If the clearance input is active (factory setting: E1) and when generator voltage as well as generator frequency ranges within the predetermined tolerances to the leading mains, a synchron impulse is generated when the grids are in phase balance (*see chap. 0*). In order to compensate delays of the switching elements, the output of synchronous impulse occurs the lead time prior to the calculated time point of synchronisation. The LEDs  $\Delta U$  and  $\Delta f$  will only be activated, if synchronisation is released.

Using analogue outputs (0(2) ... 10 V / 0(4) ... 20 mA – optionally orderable) measured values can be output to a recorder or manipulated variables can be output to controllers.

The controlling of voltage and/or frequency as well can be performed via the analogue outputs.

### 7.2 Parallel Switching Points (PSP)

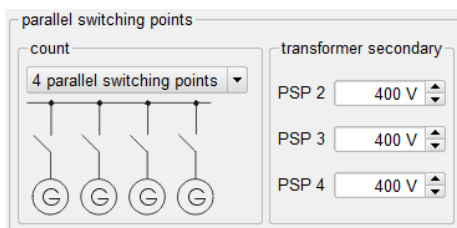

The KSY 3xx has the ability to synchronise and switch parallel up to four parallel switching points, one after the other to the leading mains (*see chap. 11.1*). If no parallel switching point is selected, PSP1 is considered active. The voltages to be synchronised must be routed to the KSY 3xx (via a higher-level controller) according to the selected PSP.

For each parallel switching point can separately be configured:

- Voltage converter ratio (secondary)
- Synchronisations parameters
- Locking relay parameters
- Set points for isolated operation (voltage, frequency)
- Controller parameters

## 7.3 Operating Modes

The KSY 3xx features several operating modes which are described in the following.

The operating modes are provided with a rank number. If several operating modes are selected at the same time, the KSY 3xx operates with the operating mode of the highest rank number.

Rank	Operating mode
3	Mains parallel mode
2	Synchronisation
1	isolated operation

Corresponding parameterised limit values are only active in correspondingly assigned operating modes (see chap. 0).

The controller parameters (if configured accordingly) as well are switched depending on the operating mode (see chap. 8 and chap. 9).

### 7.3.1 Mains parallel Mode

The KSY 3xx is situated in mains parallel mode when either the SYN pulse is output as a continuous contact (see chap. 7.7) or the 'mains parallel' input function (see chap. 11.1, function number 43) is active. The KSY 3xx regulates voltage and frequency according to the controller parameters set for mains parallel operation or, if appropriately parameterised, with global parameters (see chap. 8 and chap. 9).

### 7.3.2 Synchronisation Mode

The KSY 3xx is situated in synchronisation mode, when the input function 'SYN clearance' (see chap. 11.1, function number 20) is active and the time of 'delay-time SYN clearance' has elapsed. The KSY 3xx regulates voltage and frequency according to the controller parameters set for synchronisation mode or, if appropriately parameterised, with global parameters (see chap. 8 and chap. 9).

### 7.3.3 Isolated operation Mode

The KSY 3xx is situated in isolated operation mode, when die the input function 'isolated operation' (see chap. 11.1, function number 21) is active. Das KSY 3xx regulates voltage and frequency according to the controller parameters set for isolated operation or, if appropriately parameterised, with global parameters (see chap. 8 and chap. 9).

## 7.4 Synchronisation

### 7.4.1 Synchronisation clearance

The clearance for synchronisation is performed via the input parameterised for this purpose (see *chap. 11.1 function number 20*).

After activating the SYN clearance input, the set time 'delay-time SYN clearance' expires. After this time has elapsed, the synchronisation clearance is active internally.

When the SYN clearance is internally active, the KSY 3xx starts regulating voltage and frequency accordingly to the set parameters (see *chap. 8 and chap. 9*).

If the delta-f clearance (see *chap. 7.4.4.3*) is activated, it is checked after the synchronisation clearance.

### 7.4.2 Syn Pulse

When the SYN clearance is active internally, all the following conditions must be fulfilled in order for the sync pulse to be output to at the correct phase position:

SYN clearance is granted

Switching-on clearance must be granted (see *chap. 7.4.3*)

Switching-on voltage (generator) - if active and parameterised as SYN-preventing - must be reached or exceeded (see *chap. 7.4.3.1*)

Switching-on frequency (generator) - if active and parameterised as SYN-preventing - must be reached or exceeded (see *chap. 7.4.3.2*)

Delta-f clearance must be active (see *chap. 7.4.4.3*)

No SYN-preventing parameterised limit value may be active (see *chap. 7.8.8*)

Difference of voltage between grid and generator  $\leq$  Delta U max

Difference of frequency between grid and generator  $\leq$  Delta f max

Input function 'block switching-on' is not active (see *chap. 11.1*)

### 7.4.3 Switching-on clearance

The KSY 3xx monitors voltage and frequency of the generators for compliance with the switching-on limit values. Only when all active values are adhered, the switching-on clearance is internally enabled.

With the digital output functions under the rubric 'Switching-on' (switching-on voltage OK, switching-on frequency OK, switching-on voltage and frequency OK, switching on released), a readiness in general for switching-on can be reported to the controller.

The corresponding relay (*function 'switching-on clearance', see chap. 11.1*) is activated, when voltage and frequency of all measured phases are above of the values.

The switching-on clearance can be deactivated by means of a correspondingly parameterised (locking-) in put (*function 'block switching-on', chap. 11.1*). No sync pulse will be output in this case. This does not affect the blocking relay it continues to operate.

The switching-on clearance can as well be forced via a correspondingly parameterised input ('external switching-on clearance'). The input function 'external switching-on clearance' is

subordinated to the 'block switching on' input function. If both inputs are active, the switching-on is blocked.



If no switching-on limit value (switching-on voltage or switching-on frequency) is active, the switching-on clearance is activated via the digital input function 'external switching-on clearance'. If this input function is also not used, the conditions are deemed fulfilled and the switching-on to the grid is enabled.

### 7.4.3.1 Switching-on Voltage

This setting is used to determine the KSY 3xx at which minimum generator voltage the synchronisation is permitted. Values from 0 up to 150 % are adjustable.

When the set limit values are undershot, the assigned relay is activated. The switching-on clearance is not granted, no SYN pulse is output.

The voltage monitoring can be deactivated (blocked) by means of a parameterisable input.

Deactivating of the limit value 'switching-on voltage' is possible.

### 7.4.3.2 Switching-on Frequency

This setting is used to determine the KSY 3xx at which minimum frequency the synchronisation is permitted. Values from 35.0 up to 65.0 Hz are adjustable.

When the set limit values are undershot, the assigned relay is activated. The switching-on clearance is not granted, no SYN pulse is output.

The frequency monitoring can be deactivated (blocked) by means of a parameterisable input.

Deactivating of the limit value 'switching-on frequency' is possible.

## 7.4.4 Monitoring Functions

The KSY 3xx features the option to activate various monitoring functions. The monitoring functions allow the downstream controller to check the compliance with the set limits, before giving the synchronisation clearance voltage and frequency. In addition to the limit values, the clearance as well as the SYN pulse can be monitored.

### 7.4.4.1 Clearance Monitoring

After synchronisation clearance is granted, the clearance monitoring starts. If no sync pulse has been generated after the time has elapsed without the SYN clearance has been revoked, then this leads to the triggering of the clearance monitoring.

### 7.4.4.2 Monitoring of Synchronisation Pulse

After the SYN clearance has been carried out, the KSY 3xx monitors whether a synchronous pulse has been output within the set monitoring time. If no synchronisation occurs within the set time, the assigned relay as well as the collective fault relay are energised. After 4 seconds, this message is automatically reset. This process is repeated as long as the clearance input is closed and no synchronisation has occurred.



### 7.4.4.3 Delta-f Clearance

The Delta-f clearance ensures, that the generator grid is variable in frequency.

The delta-f clearance must be fulfilled before a synchronous pulse is output. The delta-f clearance can be set after the time of 'delay SYN clearance' has elapsed.

The delta-f clearance can be fulfilled in the following way:

The generator frequency increases once by at least  $\frac{\text{Target point frequency control}}{2}$  in relation to the mains frequency.

$$f_G \geq f_B + \frac{f_{\text{Target point frequency}}}{2}$$

The input function 'clearance delta-f' is activated (*see chap. 11.1 function number: 24*).

DIL switch 4 is closed (*see chap. 5.1.2*).

If the SYN clearance is nullified, the delta-f clearance is also reset.

### 7.4.5 Isolated Operation

If isolated operation is active via a digital input (factory setting: E2), the generator voltage and the generator frequency are independently controlled to the nominal values (deviating set points are possible).

The input 'isolated operation' is subordinated to the clearance input ('SYN clearance'), that means if both inputs are actuated at the same time, synchronising will be performed.

In isolated operation, the generator voltage and the generator frequency are controlled to the adjusted isolated operation set points. These can be set differently from the nominal values. A dead zone, in which no control takes place, can be parameterised in the controller settings.

During isolated operation, the frequency will only be controlled outside of the window 'leading frequency + dead zone'. Whilst the generator frequency moves within this window, no frequency-adjusting pulses are outputted.

## 7.5 Usage as Locking Relay

The KSY 3xx features a locking relay function (*digital outputs see chap. 12.1*). When synchronisation is enabled, this function monitors the phase angle between mains and generator and blocks the synchronisation (via relay contact) if the set deviation is exceeded. If the switch-on voltage or switch-on frequency is not reached, this contact blocks as well.

The Delta-f clearance (*see chap. 7.4.4.3*) as well as the SYN-preventing limit values (*see chap. 7.8.8*), are not relevant to the locking relay. Even the input function 'lock switching-on' has no effect on the locking relay.



## 7.6 Switching onto Dead Bus-Bar

The KSY 3xx can be parameterised in a manner, that a switching onto a so called dead bus-bar, that is a not energised bus-bar, is possible. This function has to be activated separately. If this function is activated, one of three different methods can be selected:

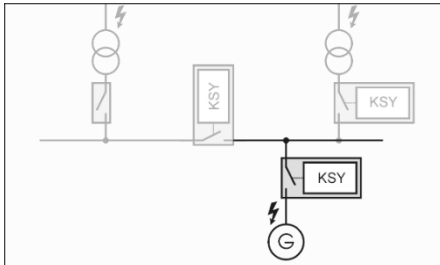

### 1. Generator to dead bus bar

The switching-on takes place to the not energised bus-bar of the leading mains (*figured left*).

The SYN pulse is output when the generator voltage lies within the set limits and the mains voltage is below the set limit value.

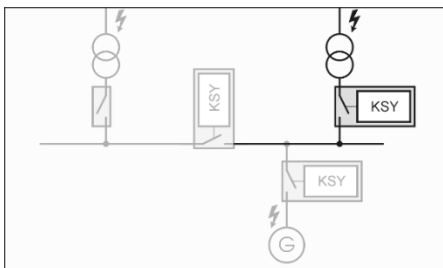

### 2. Transformer to dead bus bar

The switching-on takes place to the not energised bus-bar of the generator grid (*figured left*).

The SYN pulse is output when the values of the leading mains range within the adjusted limit values and the generator voltage (in this case transformer voltage) are below of the set limit values.

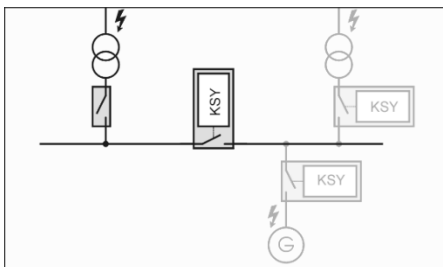

### 3. Bus rare to dead bus bar

The switching-on can be done as well to the not energised bus-bar of the leading mains, as to the not energised bus-bar of the generator grid, or if both bus bars are de-energised or voltage-carrying (then with synchronisation).

The function 'dead bus-bar active' can be assigned to an output (*see chap. 12.1 - Digital Outputs – function No 43*).

Three parameters are configurable for the dead bus-bar functionality:

- Maximum bus-bar voltage (in % of the nominal voltage)
- Minimum generator - / transformer - / bus-bar voltage (in % of  $U_G$ )
- Switching-on delay (in seconds)

After the clearance of the synchronisation (*see chap. 11.1 – function No 20*), first the delay time for synchronisation (ex works setting: 2,0 s) elapses. After this time is elapsed, the switching on delay (ex works setting: 2,0 s) goes on. During this time lapse the KSY 3xx checks, whether the mains voltage (all phases of the grid) is continuously below the adjusted limit value maximum bus-bar voltage (ex works setting: 10 %) and the generator voltage is continuously above the adjusted limit value for the minimum generator voltage (ex works setting: 80 %).

After the switch on delay time is elapsed, a sync pulse with the adjusted pulse length is emitted. When the sync pulse is ended, a new monitoring of 5 seconds starts and a once more sync pulse

will be emitted. This process will be repeated until either the synchronisation clearance is removed, or the limit value conditions for the activation of the 'dead bus-bar' are no longer met.

Furthermore, the output function 'bus-bar voltage-free' (No. 44) is available. A output relay parameterised with this function is activated when the set dead bus-bar specifications are met and the synchronisation is released via a digital input.

## 7.7 Synchronisation Pulse as permanent Contact

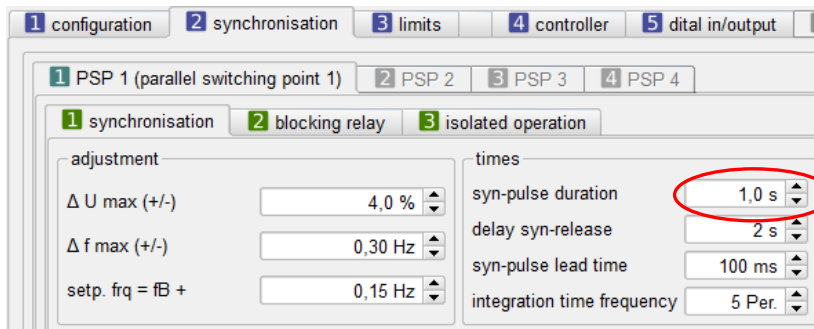

The synchronisation pulse also may be output by the KSY 3xx as permanent contact.

The permanent contact setting is made by entry of the time '0,0 s' as duration for the synchronisation impulse (*setting via device management – see figure on the left*). With this setting, the relay

picks up at the first synchronisation time point and remains tightened, until the synchronisation clearance is revoked.

## 7.8 Limit Values

### 7.8.1 Behaviour of the Limit Values

All limit values can be adjusted and assigned to a relay separately. A set and active limit value is displayed as a triggering message in the display, regardless of whether the limit value has been laid to a relay or to one of the fault messages. Each limit value message leads to the activation of the internal collective fault message and can optionally be linked to the freely configurable collective messages.

### 7.8.2 Triggering of Limit Values

The triggering is basically carried out when the respective measured value exceeds or falls short of the set limit value and the set delay time has elapsed. Each trigger value has its own delay time. The delay times are individually adjustable for each limit value in the range from 0.05 s to 999.9 s. Switching back after a limit value triggering occurs when the respective measured value has again fallen below or exceeded the set limit value plus hysteresis.

The message duration can be set between 0.1 s and 6000.0 s for each relay in the configuration of the outputs. The set value causes the corresponding relay contact to remain accessed at least for the set time, even if the exceeding or shortfall of the limit value is of shorter duration.

### 7.8.3 Manually / Automatically Reset

Factory-default all limit values are set to automatic reset. This automatic reset can be disabled for each individual limit value. If the auto-reset is activated, correspondingly configured fault messages and limit value messages are automatically reset as soon as the triggering condition no longer exists.

Limits for which the automatic reset is deactivated, can only be reset by means of a correspondingly configured digital input (see chap. 11.1 - Digital Inputs) or by long actuating of the reset-key (enter Button) while main screen is displayed. The manual reset works edge-controlled and resets all limit messages for 1 s. If limit value messages are still pending, they are again indicated with the end of the reset time.



The automatic reset is basically deactivated for all parameterised limit value messages by closing the DIL switch S1 (ON).

Resetting the fault messages by means of the Enter key (hold pressed for 2 s) is only possible while the main screen is displayed.

### 7.8.4 Disable limit values

Individual or all limit value messages can be deactivated by means of the parameterisable digital inputs (see chap. 11.1). Up to 3 blocking functions can be assigned to each limit value. The global lock function 'disable all' always deactivates all active limit messages. If the input is set, the corresponding limit value messages are suppressed.

The following lock functions are available:

- disable all limit values (default E1)
- disable 1
- disable 2
- disable 3

## 7.8.5 Central Fault

All limit value messages are entered into the central collective fault signal if the limit value message is activated, the limit value is exceeded respective fallen short of and the delay time has elapsed.

## 7.8.6 Central Fault 1+2

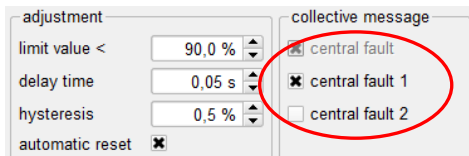

The device offers the possibility to form two independent collective fault signals. These are composed of the individual limit values. The operator thus can configure a specific event himself.

By activating the corresponding assignment, each adjustable limit value can be added to the 'collective fault 1' and/or 'collective fault 2'.

*Example:*

- Limit value setting: at Undervoltage 1, Underfrequency 2 and Vector shift 1
- Central fault 1
- Setting digital outputs: function relay 5:
- **22** = Central fault 1

This combination of the settings causes the relay 5 to be energised when at least one of the 3 limit value events occurs.

## 7.8.7 Display First Error

By means of parameterisation, the device can be specified to as whether there should only be a first value triggering (first error), or also the triggering of subsequent faults. 'Display first error only' means, that in the case of a triggering of e.g. the limit value Underfrequency 1 at a loss of one phase, an a triggering of e.g. Undervoltage 1, which is inevitably occurring as a result, no longer is evaluated. If 'display first error only' is deactivated, all the triggerings are displayed and stored in the internal error memory in the order of occurrence.

## 7.8.8 SYN-preventing Limit Value

Each limit value (with the exception of the switching-on and monitoring limit values) can be parameterised so that it is sync preventing. Such a limit value prevents synchronisation as long as it is triggered.

### 7.8.9 Operating Mode depended Release (only generator Limit Values)

The generator limit values can be activated or deactivated individually for each operating mode. Triggerings of the limit values then occur only within the operating modes activated therefor. If none of the four operating modes is activated, the generator limit values are triggered in all operating modes.

The following options are available for the generator-specific triggering of the generator limit values:

- Release at readiness for switching-on
- Release at isolated operation
- Release at SYN operation
- Release at mains parallel operation



Mains limit values are in all operating modes activated.

## 7.9 Limit Value Settings

Each limit value can be set individually and is shown below.

Percentagewise adjustable limit values always refer to the respective configured nominal value.

### 7.9.1 Rotary Field Monitoring (Mains and/or Generator)

Function	Range	Hysteresis	Delay time	Permissible deviation
Monitoring of rotary field mains / generator	left / right	10°	0.5 s	+/-1.0° -0.01 / +0.02 s

The respective smallest or largest of the three phase angles is used as the trigger criterion for the rotary field monitoring. If it exceeds- or falls below 180 °, the signal 'rotary field error' is generated and output. Thereby the KSY 3xx differentiates according to the internal and external rotary field, in order to detect any faults in the wiring. The rotary field error has no effect on the other error signals. The monitoring can be adjusted on left or right rotary field by the parameterisation software. Ex works, the rotary field monitoring of the KSY 3xx is not activated.



For the monitoring of the rotation field, hysteresis and delay time are fixed preset and can not be adjusted.

### 7.9.2 Monitoring of Angle Error (Mains and/or Generator)

Function	Range	Hysteresis	Delay time	Permissible deviation
Angle min. mains	-5.0 ... -60.0°	1° ... 20°	0.05 s ... 999.99 s	+/-0.5° -0.01 / +0.02 s
Angle max. mains	5.0 ... 60.0°	1° ... 20°	0.05 s ... 999.99 s	+/-0.5° -0.01 / +0.02 s
Angle min. generator	-5.0 ... -60.0°	1° ... 20°	0.05 s ... 999.99 s	+/-0.5° -0.01 / +0.02 s
Angle max. generator	5,0 ... 60,0°	1° ... 20°	0,05 s ... 999,99 s	+/-0,5° -0,01 / +0,02 s

The angle error monitoring is in two stages executed and checks the deviation of the phase angle of two successive phases L1-L2, L2-L3, L3-L1 from the normal case (120°). The amount of the deviation of 120° is used as limit value specification.

*Example:*

Angle error		
Angle 1	15°	If the phase angle L1-2 falls short of the value of 105° (120° - 15°) or if it exceeds the value of 135° (120° + 15°) for the duration of 0.08 s, the signal 'Angle error 1' is set.
Delay time	0.08 s	Switching back occurs as soon, as the angle than again exceeds the value of 106° (120° - 15° + 1°), falls below of the value of 134°.
Hysteresis	1°	

### 7.9.3 Voltage Triggering – Under-/Overvoltage (Mains and/or Generator)

Function	Range	Hysteresis	Delay time	Permissible deviation
Undervoltage mains	10.0...199.9 %	0.5...50.0 %	0.05 s ... 999.99 s	+/-0.1 % -0.01 / +0.02 s
Overvoltage mains	10.0...199.9 %	0.5...50.0 %	0.05 s ... 999.99 s	+/-0.1 % -0.01 / +0.02 s
Undervoltage generator	10.0...199.9 %	0.5...50.0 %	0.05 s ... 999.99 s	+/-0.1 % -0.01 / +0.02 s
Overvoltage generator	10.0...199.9 %	0.5...50.0 %	0.05 s ... 999.99 s	+/-0.1 % -0.01 / +0.02 s

Each limit value has its own triggering delay.

*Example:*

Undervoltage		
Limit value	90 %	If the voltage of one phase falls short of 90,0 % (207 V at 230 V nominal voltage), the signal 'Undervoltage 1' is set after 0.08 s.
Delay time	0.08 s	The switching back occurs as soon as all phases have again exceeded the value of 90,5 % (208,2 V).
Hysteresis	0.5 %	

### 7.9.4 Voltage Asymmetry Triggering (Mains and/or Generator)

Function	Range	Hysteresis	Delay time	Permissible deviation
Asymmetry mains	1.0...100.0 %	0.5...50.0 %	0.05 s...999.99 s	+/-0.1 % -0.01 / +0.02 s
Asymmetry generator	1.0...100.0 %	0.5...50.0 %	0.05 s...999.99 s	+/-0.1 % -0.01 / +0.02 s

For the asymmetry monitoring, a limit value for the maximum permissible deviation of the voltage between two phases has to be entered in % of the nominal voltage. The voltage asymmetry limit is triggered as well on loss of a phase voltage.

*Example:*

<b>Asymmetry</b>		If the voltage difference between two phases exceeds 10.0 % (L1 = 235 V, L2 = 211 V, L3 = 230 V at 230 V nominal voltage), the signal 'Voltage asymmetry is set after 0.05 s. The switching back occurs as soon as the difference becomes less than 9 % (10.0 % - 1.0 %).
Limit value	10 %	
Delay time	0.05 s	
Hysteresis	1.0 %	

### 7.9.5 Deviation of Voltage Mean Value (Mains and/or Generator)

Function	Range	Hysteresis	Delay time	Permissible deviation
Mean value dev. mains	1.0 ... 100.0%	0.5 ... 50.0 %	0.05 s...999.99 s	+/-0.1 % -0.01 / +0.02 s
Mean value dev. generator	1.0 ... 100.0%	0.5 ... 50.0 %	0.05 s...999.99 s	+/-0.1 % -0.01 / +0.02 s

If deviation of mean value is enabled, the KSY 3xx monitors the average of the 3 external conductor voltages on fall short of the set limit value according to the following formula:

$$X \% < ((U12 \% + U23 \% + U31 \% ) / 3)$$

*Example:*

<b>Mean value</b>		If, at U12 = 91,0 %, U23 = 90,3 %, U31 = 78,7 %, the mean value is 86,6 %, triggering is executed after 1.0 s. Die Switching back occurs as soon as the mean value than again exceeds 91.0 %.
Limit value	90 %	
Delay time	1.00 s	
Hysteresis	1.0 %	



### 7.9.6 Frequency Triggering Under-/Overfrequency (Mains and/or Generator)

Function	Range	Hysteresis	Delay time	Permissible deviation	
Underfrequency mains	35.00...65.00 Hz	0.05...2.00 Hz	0.05 s ...999.99 s	+/- 0.01 Hz	-0.01 / +0.02 s
Overfrequency generator	35.00...65.00 Hz	0.05...2.00 Hz	0.05 s ...999.99 s	+/- 0.01 Hz	-0.01 / +0.02 s
Underfrequency mains	35.00...65.00 Hz	0.05...2.00 Hz	0.05 s ...999.99 s	+/- 0.01 Hz	-0.01 / +0.02 s
Overfrequency generator	35.00...65.00 Hz	0.05...2.00 Hz	0.05 s ...999.99 s	+/- 0.01 Hz	-0.01 / +0.02 s

For the under- / overfrequency detection, two different limit values are adjustable. Each limit value has its own triggering delay time.

*Example:*

#### Overfrequency Mains

Limit value 51,20 Hz  
Delay time 0,08 s  
Hysteresis 0,10 Hz

If the frequency of one phase exceeds 51.20 Hz, the signal 'Overfrequency 1' is set after 0,08 s. The switching back occurs as soon as the frequency falls below 51.10 Hz again.

### 7.9.7 Vector Shift Triggering (Mains)

Function	Range	Hysteresis	Delay time	Permissible deviation	
Vector shift mains	5,0 ... 45.0°	-	0.03 s	+/-0.1°	-0.01 / +0.02 s

The vector shift detection takes place two staged and can be adjusted in various combinations. The input is done in angular degrees relative to a full-wave (period) with 360°. The signal 'Vector shift' features a systematic delay of approximately 0,03 s.

Possible combinations are:

*Example:*

#### Vector shift mains

Limit value 8.0°  
Combination L1 and  
L2 and  
L3

No.	Function
0	L1 or L2 or L3
1	only L1
2	only L2
3	only L3
4	L1 and L2 and L3
5	L1 and L2 and L3 (differenced vector shift)

If a vector shift of at least 8.1° occurs at all 3 phases, the signal 'Vector shift mains' will be generated and output.



### 7.9.8 Delta f to Delta t (ROCOF) (Mains)

Function	Range	Hysteresis	Delay time	Permissible deviation
ROCOF Mains	0.01...10.00 Hz/s	-	0.05...999.99 s	+/-0,01 Hz -0.01 / +0.02 s

The as well two stage executed limit value function  $\Delta f/\Delta t$  (ROCOF - rate of change of frequency) offers the possibility to detect frequency changes alternatively or parallel to the vector shift detection.

Example:

ROCOF Mains		The triggering occurs, when the frequency alters with a speed of 0,5 Hz/s for a minimum period of 0,1 s. In this example at an alteration of >0,05 Hz in 0,1 s.
Limit value	0.50 Hz/s	
Delay time	0.10 s	

### 7.9.9 Slip

Function	Range	Hysteresis	Delay time	Permissible deviation
Slip	-0.01 ... -50.00 Hz	-	0.2 ... 999.99 s	+/-0.01 Hz -0.01 / +0.02 s

The Slip is calculated as follows:

$$s = |f_B - f_G|$$

Example:

Slip		The triggering occurs when the slip is greater than 0.5 Hz for the duration of at least 0.1 s. Switching back occurs as soon, as the slip is smaller than 0.3 Hz.
Limit value	0.50 Hz	
delay time	0.10 s	
Hysteresis	0.2 Hz	

### 7.10 Trigger Memory

The KSY 3xx stores the measured values for the respective limit value triggerings. The error memory can store the values of up to 58 trigger events. The trigger values are permanently stored in the flash memory of the device with the date and time and are retained even in case of loss of the auxiliary voltage. The number of detected triggerings is stored in a counter (maximum 65,000; can not be erased; reset to 0 if exceeded). The trigger values can be read on the device. The trigger memory can be read out as well via KuPa010 (see chap. 7.10.1).

The output of the triggerings on the device's graphic display is called up by closing the DIL switch S4 (see chap. 5.1.2 - DIL Switches) while in the operation mode the main screen is displayed. First, the last triggering is shown. Actuating the UP button (for the function of the buttons see chap. 0 -

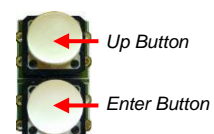

Buttons), the different values of the triggering can be viewed. Using the Enter button, one can scroll backwards through the stored triggerings. When the oldest stored triggering is reached, the display returns back to the most recently stored triggering.

The stored triggering values are cleared by holding pressed down the UP button for approx. 10 seconds while the DIL switch S4 is closed (*display output figured right*). Then all previously stored triggering values, but not the counter reading for all triggerings (*refer above*), are erased.

```

** ACHTUNG **
löschen      /   delete
Speicher     /   memory
              in   3.7 s
    
```

### 7.10.1 Reading out the Trigger Memory

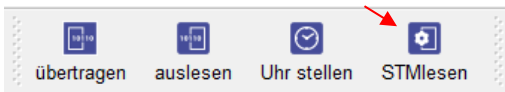

The trigger memory of the KSY 3xx can be read out with the parameterisation software KuPa010 by clicking the corresponding button (figured left). In the window that

appears thereupon, all stored fault messages are listed chronologically. The fault messages can be stored as plain text file (\*.txt) on the PC system.

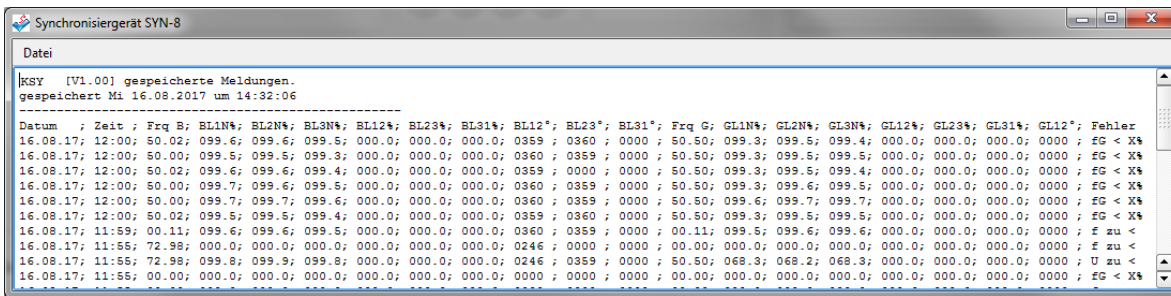

### 7.11 Programmable Switching Points

In addition to the adjustable limit values, the KSY 3xx has 3 programmable switching points. Each switching point can be assigned to a selection of functions. Hereby switching behaviour, hysteresis and a deceleration time can be set. The following values are available:

No	Function	Description
0	without function	Output is inactive
1	Voltage mains L1-N	Mains voltage L1 scaled in xx.x % of the nominal voltage
2	Voltage mains L2-N	Mains voltage L1 scaled in xx.x % of the nominal voltage
3	Voltage mains L3-N	Mains voltage L1 scaled in xx.x % of the nominal voltage
4	Voltage mains average L1-N / L2-N / L3-N	Mean value of the mains neutral point voltages in xx.x % of the nominal voltage
5	Voltage mains L1-L2	Mains voltage L12 scaled in xx.x % of the nominal voltage
6	Voltage mains L2-L3	Mains voltage L23 scaled in xx.x % of the nominal voltage
7	Voltage mains L3-L1	Mains voltage L31 scaled in xx.x % of the nominal voltage

8	Voltage mains average L12 / L23 / L31	Mean value of the mains external conductor voltages in xx.x % of the nominal voltage
9	Voltage generator L1-N	Generator voltage L1 scaled in xx.x % of the nominal voltage
10	Voltage generator L2-N	Generator voltage L2 scaled in xx.x % of the nominal voltage
11	Voltage generator L3-N	Generator voltage L3 scaled in xx.x % of the nominal voltage
12	Voltage generator average L1-N / L2-N / L3-N	Mean value of the generator neutral point voltages in xx.x % of the nominal voltage
13	Voltage generator L1-L2	Generator voltage L12 scaled in xx.x % of the nominal voltage
14	Voltage generator L2-L3	Generator voltage L23 scaled in xx.x % of the nominal voltage
15	Voltage generator L3-L1	Generator voltage L31 scaled in xx.x % of the nominal voltage
16	Voltage generator average L12 / L23 / L31	Mean value of the generator external conductor voltages in xx.x % of the nominal voltage
17	Mains L1	Mains frequency L1 scaled in xx.xx Hz
18	Generator L1	Generator frequency L1 scaled in xx.xx Hz

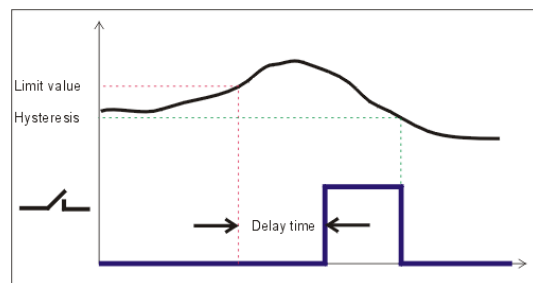
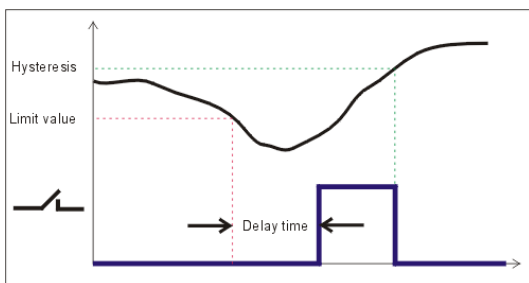

Each switching point can be assigned to a relay output (see chap. 12.1 - Digital Outputs). The output relay then switches according to the parameterisation when the respective measured value is exceeded or undershot. No messages are displayed.



Switching points are NOT considered in the fault message processing!

## 8 PID-T1 Controller

For controlling of the voltage and the frequency, the KSY 3xx features two independent, integrated PID-T1 controllers, which can be assigned to the two available analogue outputs.

'PID-T1 1' regulates the voltage, 'PID-T1 2' the frequency.

To activate the PID-T1 controllers, the analogue outputs on the device must be activated and the PID-T1 controllers must be assigned to the respectively provided analogue output.

If a PID controller is assigned to an analogue output, the analogue output can be applied with an offset. This causes a raising in the analogue output quantity by the set amount; thus, for example, a control difference of '0' at an analogue output offset of 5 V, can cause an output voltage of 5 V.

In the operating modes, the following controller set points are underlying:

Operating mode	Voltage controller	Frequency controller
isolated operation	<i>nominal voltage island operation</i>	<i>nominal frequency island mode</i>
Sync operation	<i>mains voltage</i>	<i>mains frequency + x</i> (x: adjustable)
Mains parallel	<i>mains voltage</i>	<i>mains frequency</i>

Each parallel switching point can be configured with its own controller parameter set. It is also possible to specify independent controller parameters for the individual operating states.

### 8.1 Controller Ramps

On clearance respectively blocking, a ramp time can be set in each case in order to reach the set point value within the set time, thus avoiding jumps. The ramp time is adjustable in the range from 0.0 s to 600.0 s.

### 8.2 Dead Zone

For the target point, a dead zone in x.x% of the set point can be set. If the actual value reaches this range, the control is stopped and continues only after leaving the set range. The dead zone can be adjusted in the range from 0 to 50.0%.

### 8.3 Clearance Delay

A clearance delay can be set for activating the controllers. This time causes the respective controller to become active only after this time has expired. The clearance delay is adjustable in the range from 0.0 s to 600.0 s.

## 8.4 Controller Parameters

The seven following values are adjustable for the PID-T1 controllers:

Function	Range	Permissible deviation
1. Amplification $K_p$	0.01 ... 10.00	-
2. Integration time $T_n$	0.0 ... 999.9 s	+/- 0.1 s
3. Derivative time $T_v$	0.0 ... 99.9 s	+/- 0.1 s
4. Readjust time $T_1$	0.0 ... 99.9 s	+/- 0.1 s
5. Release delay	0.0 ... 600.0 s	+/- 0.5 s
6. Ramp time	0.0 ... 600.0 s	+/- 0.5 s
7. Dead zone	0.0 ... 50.0 %	0.02 %

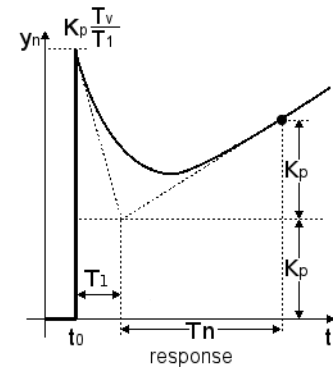

## 9 Pulse Controller

For controlling of the voltage and the frequency, the KSY 3xx features two independent, integrated pulse controllers, whose pulses can be assigned to the digital outputs (relays) (see *chap. 12.1 - Digital Outputs*).

'Pulse controller 1' regulates the voltages, 'Pulse controller 2' the frequency.

To activate the corresponding pulse controller, at least one of its control pulses must be assigned to a digital output.

The control impulses (+ / -) output by the pulse controllers can also be set via appropriately parameterised digital inputs.

In the operating modes, the following controller set points are underlying:

Operating mode	Voltage controller	Frequency controller
Isolated operation	<i>nominal voltage island operation</i>	<i>nominal frequency island mode</i>
Sync operation	<i>mains voltage</i>	<i>mains frequency + x</i> (x: adjustable)
Mains parallel	<i>mains voltage</i>	<i>mains frequency</i>

Each parallel switching point can be configured with its own controller parameter set. It is also possible to specify independent controller parameters for the individual operating states.

Both pulse controllers can be configured as pulse frequency controllers or as pulse width controllers (this setting applies to each operating mode of a parallel switching point).

The controllers can be released respectively blocked via parameterisable input functions.

The set point usually is set internally. With the Miniature PC option, the set point specification from the external source is possible.

## 9.1 PFM (Pulse Frequency Modulation)

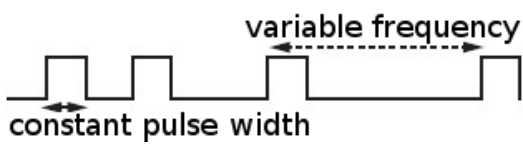

In the case of modulation type PFM, the control pulse has a fixed pulse length respectively pulse duration. The pulse pause or the frequency varies depending on the control difference (and the set amplification). The larger the deviation, the more (equal-length) pulses per minute.

### 9.1.1 Controller Parameters

For the PFM pulse controller, four values (different for each PSP, different for each operating mode, *figured right*) are adjustable.

- Amplification  $K_p$  in impulses/% per minute:  
The value set here corresponds to a pulse count of  $K_p$  pulses per minute with a % control deviation.  
Example 1:  $K_p = 1.00$ , control deviation = 2 % -> 2 pulses per minute  
Example 2:  $K_p = 5.00$ , control deviation = 2 % -> 10 pulses per minute  
Example 3:  $K_p = 0.10$ , control deviation = 12 % -> 1.2 pulses per minute
- Pulse duration  $T$  adjustable in 0.1 sec steps:  
The value set here determines the switch on duration of the associated output relay. If the interval between 2 control pulses is less than the switch on duration, the output relay will change over to the permanent contact.

Parameter	Range	Tolerance
Amplification Imp/%	0.01...99.99	-
Pulse duration	0.1...999.9 s	+/- 0.05 s
Release delay	0.0...600.0 s	+/- 0.5 s
Dead zone	0.0 ... 50.0 %	0.02 %

- Release delay in 0.1 sec steps:  
The controller is blocked after activation for the duration of the enable delay.
- Dead zone in 0.1 % steps:  
If the control deviation is less equal the set dead zone, the controller does not output any control pulses.

## 9.2 PWM (Pulse Width Modulation)

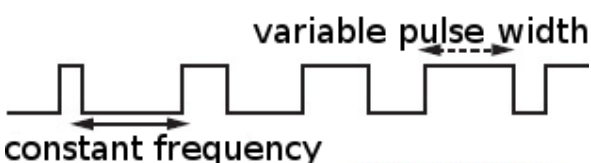

At the modulation type PWM, the frequency is fixed. The pulse length or pulse duration changes depending on the control deviation (and the adjusted amplification).

If no control deviation occurs, no pulse is output. At a 100 % control deviation (and an amplification of 1) a permanent pulse is output.

## 9.2.1 Controller Parameters

For the PWM pulse controller, four values (different for each PSP, different for each operating mode, *figured right*) are adjustable.

- Amplification Kp

The value set here corresponds to the ratio between pulse and pause at one per cent of the control difference.

Example 1:  $K_p = 1.00$  control difference = 2 %  $\rightarrow$  2 % of the period duration, the output is accessed

Example 2:  $K_p = 5.00$  control difference = 2 %  $\rightarrow$  10 % of the period duration, the output is accessed

Example 3:  $K_p = 20.00$  control difference = 5 %  $\rightarrow$  100 % of the period duration, the output is accessed.

Parameter	Range	Tolerance
Amplification Imp/%	0.01...99.99	-
Period duration	0.1... 99.9 s	+/- 0.05 s
Release delay	0.0...600.0 s	+/- 0.5 s
Dead zone	0.0 ... 50.0 %	0.02 %

- Period duration T adjustable in 0.1 sec steps  
The value set here determines the period duration of the output relay. If the pause time between 2 control pulses gets less than the switch-on duration, the output relay switches to permanent contact.
- Release delay in 0.1 sec steps:  
The controller is blocked after activation for the duration of the enable delay.
- Dead zone in 0.1 % steps:  
If the control deviation is less equal the set dead zone, the controller does not output any control pulse.

## 9.3 Dead Zone

For the target point, a dead zone in x.x % of the set point can be adjusted. If the actual value reaches this range, the control is stopped and continues only after leaving the set range. The dead zone can be adjusted in the range from 0 to 50.0 %.

## 9.4 Release Delay

For the activating the controllers, a clearance delay time can be set. This setting causes the respective controller only becomes active when, after the input function is set, this time has expired. The clearance delay is adjustable in the range from 0.0 s to 600.0 s.

## 10 Electronic Potentiometer

The KSY 3xx features two internal electronic potentiometers whose 'outputs' can be laid on the existing analogue outputs.

The 'Electronic Poti 1' reacts on voltage control pulses,  
The 'Electronic Poti 2' reacts on frequency control pulses.

The control pulses of the pulse controllers are internally linked as actuating variables for the electronic potentiometers. In addition, digital input functions (see chap. 11.1 - Digital Inputs) can be used for adjusting and resetting the potentiometers (control pulse higher, control pulse lower, reset).

If the potentiometer is reset (see chap. 11.1 function number: 35, 36), its output jumps to the set offset.

### 10.1 Parameters

The following parameter are adjustable:

Parameter	Range	Tolerance
Swing	0.01 ... 10.00 V	-
Offset	0.00 ... 10.00 V	+/- 0.05 s
Ramp	0.1 ... 250.0 s	+/- 0.5 s

- Swing: This parameter determines the maximum alteration from the offset, in the plus and minus direction.
- Offset: This parameter determines the 'zero point' of the electronic potentiometer. The output jumps to this value, when the potentiometer is reset.
- Ramp: This parameter determines the speed of change of the output. The potentiometer requires the set ramp time from the lowest to the highest parameterised value:  $2 \times \text{swing}$ .

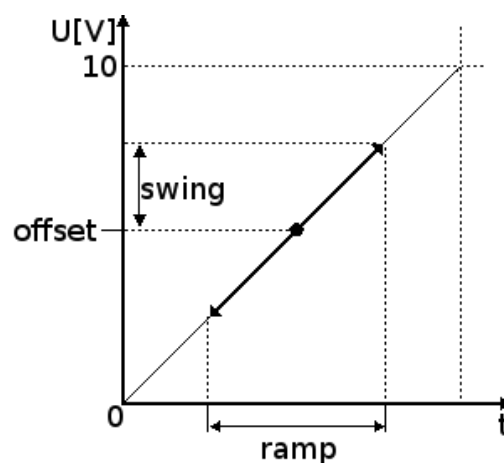



## 11 Inputs

### 11.1 Digital Inputs

The KSY 3xx features 3 digital inputs, which can be assigned to one of the following functions:

No.	Function	Description
0	deactivated	Input is not active. Allocation of an output with the terminal of this input is however possible.
1	Global disable	All limit value messages are suppressed as long as the input is active.
2	Disable 1	All limit value messages, which are parameterised with lock 1 are suppressed as long as the input is active.
3	Disable 2	All limit value messages, which are parameterised with lock 2 are suppressed as long as the input is active.
4	Disable 3	All limit value messages, which are parameterised with lock 3 are suppressed as long as the input is active.
5	Fault reset	Reset of limit value messages, which are not set to 'Auto reset'.
6	Change language	Changing of the display language depending on the parameter setting. The language switching can be deactivated.
10	Feedback A1 REL1 – KL9	Monitoring of the feedback of the contactor connected to A1. In the event of a fault, the 'collective fault' signal is set after 0.5 s (see chap. 11.1.1 - Monitoring of the Relay- (Contactor-) Acknowledgement 11.1.1).
11	Feedback A2 REL2 – KL10	Monitoring of the feedback of the contactor connected to A2. In the event of a fault, the 'collective fault' signal is set after 0.5 s (see chap. 11.1.1 - Monitoring of the Relay- (Contactor-) Acknowledgement 11.1.1).
12	Feedback A3 REL3 – KL11	Monitoring of the feedback of the contactor connected to A3. In the event of a fault, the 'collective fault' signal is set after 0.5 s (see chap. 11.1.1 - Monitoring of the Relay- (Contactor-) Acknowledgement 11.1.1).
13	Feedback A4 REL4 – KL12	Monitoring of the feedback of the contactor connected to A4. In the event of a fault, the 'collective fault' signal is set after 0.5 s (see chap. 11.1.1 - Monitoring of the Relay- (Contactor-) Acknowledgement 11.1.1).
14	Feedback A5 REL5 – KL13/14/15	Monitoring of the feedback of the contactor connected to A5. In the event of a fault, the 'collective fault' signal is set after 0.5 s (see chap. 11.1.1 - Monitoring of the Relay- (Contactor-) Acknowledgement 11.1.1).

No.	Function	Description
15	Feedback A6 REL6 – KL26/27	Monitoring of the feedback of the contactor connected to A6. In the event of a fault, the 'collective fault' signal is set after 0.5 s (see chap. 11.1.1 - Monitoring of the Relay- (Contactor-) Acknowledgement 11.1.1).
20	SYN clearance	Release of the synchronisation.
21	Isolated operation	Isolated operation is activated (Input is subordinated to SYN clearance. If both inputs are set, SYN clearance is selected).
22	External switch-on clearance	The switching-on clearance can be set external.
23	disable switch-on	Locks the switching-on. This input is superordinated to the external switching-on clearance. If both inputs are active, the switching-on is blocked.
24	delta-f clearance	The internal delta-f monitoring can be 'levered out' by this input function, so that the result of the monitoring is positive.
25	Show synchronoscope	The synchronoscope is displayed, when the input is set.
26	PSP choice 2	Parallel switching point 2 is selected.
27	PSP choice 3	Parallel switching point 3 is selected.
32	PSP choice bit 1	Binary input 1 for the PSP selection
33	PSP choice bit 2	Binary input 2 for the PSP selection
34	PSP choice bit 3	Binary input 3 for the PSP selection
35	Electronic potentiometer voltage reset	The voltage output of the electronic potentiometer is reset (jumps to the set offset).
36	Electronic potentiometer frequency reset	The frequency output of the electronic potentiometer is reset (jumps to the set offset).
37	Control pulse voltage +	The selected regulation increases the voltage of the generator.
38	Control pulse voltage -	The selected regulation decreases the voltage of the generator.
39	Control pulse frequency +	The selected regulation increases the frequency of the generator.
40	Control pulse frequency -	The selected regulation decreases the frequency of the generator.
41	PID controller voltage reset	The PID-T1 controller 1 (voltage) is reset (switches onto the adjusted offset).

No.	Function	Description
42	PID controller frequency reset	The PID-T1 controller 2 (frequency) is reset (switches onto the adjusted offset).
43	Mains parallel operation	Mains parallel operation is activated.

### 11.1.1 Monitoring of the Relay- (Contactor-) Acknowledgement

If a digital input is assigned with the feedback function, the corresponding message and the collective message are set after 0.5 s, if the acknowledgement contact of the corresponding relay does not correspond to the state of the relay.

## 12 Outputs

### 12.1 Digital Outputs

The KSY 3xx features 3 groups of digital outputs (A1 - A4, A5 and A6) with in total 6 relays. One of the following functions can be assigned to each of these:

No.	Function	Description
0	Without function	The output is deactivated. If the output is parameterised as per closed circuit principle, the relay is permanently energised.
1	Ready for use	The corresponding relay is energised, when the KSY 3xx is ready for operation.
2	Central fault	The corresponding relay is energised, when the 'collective fault' is set.
3	Central fault 1	The corresponding relay is energised, when the 'collective fault 1' is set.
4	Central fault 2	The corresponding relay is energised, when the 'collective fault 2' is set.
5	Rotary field error mains	The corresponding output relay is activated if the applied rotary field of the mains does not match the parameterised rotary field (right or left).
6	Rotary field error generator	The corresponding output relay is activated if the applied rotary field of the generator does not match the parameterised rotary field (right or left).
7	Rotary field mains & generator OK	The associated output relay is activated when the applied rotary fields of the mains as well as of the generator coincide with the parameterised rotary field (right or left).
8	Angle mains	The associated output relay is activated when the limit value 'angle mains' is exceeded and the delay time has elapsed.

No.	Function	Description
9	Angle generator	The associated output relay is activated when the limit value 'angle generator' is exceeded and the delay time has elapsed.
10	Angle OK	The associated output relay is activated if neither the limit value 'angle mains' nor the limit value 'angle generator' has been exceeded.
11	Undervoltage mains	The corresponding output relay is activated when the limit value 'Undervoltage Mains' is undershot and the delay time has elapsed.
12	Undervoltage generator	The corresponding output relay is activated when the limit value 'Undervoltage Generator' is undershot and the delay time has elapsed.
13	Undervoltage mains or generator	The associated output relay is activated when either the limit value 'Undervoltage Mains' or the limit value 'Undervoltage Generator' is undershot and the delay time has elapsed.
14	Overvoltage mains	The corresponding output relay is activated when the limit value 'Overvoltage Mains' is exceeded and the delay time has elapsed.
15	Overvoltage generator	The corresponding output relay is activated when the limit value 'Overvoltage Generator' is exceeded and the delay time has elapsed.
16	Overvoltage mains or generator	The associated output relay is activated when either the limit value 'Overvoltage Mains' or the limit value 'Overvoltage Generator' is exceeded and the delay time has elapsed.
17	Asymmetry mains	The corresponding output relay is activated, when the limit value 'Asymmetry Mains' is exceeded and the delay time has elapsed.
18	Asymmetry generator	The corresponding output relay is activated, when the limit value 'Asymmetry Generator' is exceeded and the delay time has elapsed.
19	Mean value mains	The corresponding output relay is activated, when the limit value 'Mean Value Mains' is exceeded and the delay time has elapsed.
20	Mean value generator	The corresponding output relay is activated, when the limit value 'Mean Value Generator' is exceeded and the delay time has elapsed.
21	Voltage quality mains	The corresponding output relay is activated, when the limit value 'Voltage Quality Mains' is exceeded and the delay time has elapsed.
22	Voltage mains OK	The corresponding output relay is activated, when the limit values 'Undervoltage Mains' and 'Overvoltage Mains' are not active.

No.	Function	Description
23	Voltage generator OK	The corresponding output relay is activated, when the limit values 'Undervoltage Generator' and 'Overvoltage Generator' are not active.
24	Underfrequency mains	The corresponding output relay is activated when the limit value 'Underfrequency Mains' is undershot and the delay time has elapsed.
25	Underfrequency generator	The corresponding output relay is activated when the limit value 'Underfrequency Generator' is undershot and the delay time has elapsed.
26	Underfrequency mains or generator	The associated output relay is activated when either the limit value 'Underfrequency Mains' or the limit value 'Underfrequency Generator' is undershot and the delay time has elapsed.
27	Overfrequency mains	The corresponding output relay is activated when the limit value 'Overfrequency Mains' is exceeded and the delay time has elapsed.
28	Overfrequency generator	The corresponding output relay is activated when the limit value 'Overfrequency Generator' is exceeded and the delay time has elapsed.
29	Overfrequency mains or generator	The associated output relay is activated when either the limit value 'Overfrequency Mains' or the limit value 'Overfrequency Generator' is exceeded and the delay time has elapsed.
30	Vector shift mains	The corresponding output relay is activated when the limit value 'Vector Shift Mains' is exceeded and the delay time has elapsed.
31	ROCOF mains	The corresponding output relay is activated when the limit value 'ROCOF Mains' is exceeded and the delay time has elapsed.
32	Slip	The corresponding output relay is activated when the limit value 'Slip' is exceeded and the delay time has elapsed.
33	Frequency mains OK	The corresponding output relay is activated when the limit values 'Underfrequency Mains' and 'Overfrequency Mains' are not active.
34	Frequency generator OK	The corresponding output relay is activated when the limit values 'Underfrequency Generator' and 'Overfrequency Generator' are not active.
35	Switch-on voltage OK	The associated output relay is activated when the switching-on voltage is reached.
36	Switch-on voltage not OK	The associated output relay is activated when the switching-on voltage not is reached.
37	Switch-on frequency OK	The associated output relay is activated when the switching-on frequency is reached.

No.	Function	Description
38	Switch-on frequency not OK	The associated output relay is activated when the switching-on frequency not is reached.
39	Switch-on voltage AND Switch-on frequency OK	The corresponding output relay is activated when the Switching-on voltage and the Switching-on frequency are reached.
40	Switching-on released	The corresponding output relay is activated when the Switching-on is released ( <i>see chap. 7.4.3</i> ).
41	Release error	The corresponding output relay is activated when the limit value 'Release Monitoring' is triggered.
42	Sync pulse error	The corresponding output relay is activated when the limit value 'Sync Pulse Monitoring' is triggered.
43	Dead bus bar active	The associated output relay is activated when the SYN clearance is granted and the voltage of the corresponding dead bus-bar ranges below of the adjusted voltage and the voltage of the energised ranges above of the adjusted voltage.
44	Bus-bar not energised	The associated output relay is activated when the SYN clearance is granted and the voltage of the corresponding dead bus-bar ranges below of the adjusted voltage.
45	Impulse controller voltage +	The corresponding output relay is accessed when the voltage impulse controller emits a positive pulse.
46	Impulse controller voltage -	The corresponding output relay is accessed when the voltage impulse controller emits a negative pulse.
47	Impulse controller frequency +	The corresponding output relay is accessed when the frequency impulse controller emits a positive pulse.
48	Impulse controller frequency -	The corresponding output relay is accessed when the frequency impulse controller emits a negative pulse.
49	Input E1 - TML2	The corresponding output relay is activated, when the digital input E1 at terminal 2 ( <i>see chap. 4.2.1 - Connection Diagram</i> ) is closed.
50	Input E2 - TML3	The corresponding output relay is activated, when the digital input E1 at terminal 3 ( <i>see chap. 4.2.1 - Connection Diagram</i> ) is closed.
51	Input E3 - TML4	The corresponding output relay is activated, when the digital input E1 at terminal 4 ( <i>see chap. 4.2.1 - Connection Diagram</i> ) is closed.
52	Error reset	The corresponding output relay is energised when the manual error reset function via digital input or Enter button is activated ( <i>see chap. 11.1</i> ).

No.	Function	Description
53	Language switching	The associated output relay is energised when the language switching via digital input is activated ( <i>see chap. 11.1</i> ).
54	Show synchronoscope	The associated output relay is energised when the displaying of synchronoscope is activated via digital input ( <i>see chap. 11.1</i> ).
55	Block all triggerings	The corresponding output relay is energised when the input function 'Block all triggerings' is activated ( <i>see chap. 11.1</i> ).
56	Lock 1	The corresponding output relay is energised when the input function 'Lock 1' is activated ( <i>see chap. 11.1</i> ).
57	Lock 2	The corresponding output relay is energised when the input function 'Lock 2' is activated ( <i>see chap. 11.1</i> ).
58	Lock 3	The corresponding output relay is energised when the input function 'Lock 3' is activated ( <i>see chap. 11.1</i> ).
59	Acknowledgement A1	The corresponding output relay is energised, if the function 'Acknowledgement A1' via digital input ( <i>see chap. 11.1</i> ) is activated.
60	Acknowledgement A2	The corresponding output relay is energised, if the function 'Acknowledgement A2' via digital input ( <i>see chap. 11.1</i> ) is activated.
61	Acknowledgement A3	The corresponding output relay is energised, if the function 'Acknowledgement A3' via digital input ( <i>see chap. 11.1</i> ) is activated.
62	Acknowledgement A4	The corresponding output relay is energised, if the function 'Acknowledgement A4' via digital input ( <i>see chap. 11.1</i> ) is activated.
63	Acknowledgement A5	The corresponding output relay is energised, if the function 'Acknowledgement A5' via digital input ( <i>see chap. 11.1</i> ) is activated.
64	Acknowledgement A6	The corresponding output relay is energised, if the function 'Acknowledgement A6' via digital input ( <i>see chap. 11.1</i> ) is activated.
65	SYN clearance	The corresponding output relay is energised when the input function 'SYN clearance' ( <i>see chap. 11.1</i> ) is activated.
66	Isolated operation	The corresponding output relay is energised when the input function 'Isolated Operation' ( <i>see chap. 11.1</i> ) is activated.
67	External switching-on clearance	The corresponding output relay is energised when the input function 'external switching-on clearance' ( <i>see chap. 11.1</i> ) is activated.
68	Release delta-f	The corresponding output relay is energised when the input function 'clearance delta-f' ( <i>see chap. 11.1</i> ) is activated.
69	PSP 2 selected	The associated output relay is energised when the input function 'PSP choice 2' ( <i>see chap. 11.1</i> ) is activated.



No.	Function	Description
70	PSP 3 selected	The associated output relay is energised when the input function 'PSP choice 3' (see chap. 11.1) is activated.
71	PSP 4 selected	The associated output relay is energised when the input function 'PSP choice 4' (see chap. 11.1) is activated.
75	PSP bit 1 selected	The associated output relay is energised when the input function 'PSP choice bit 1' (see chap. 11.1) is activated.
76	PSP bit 2 selected	The associated output relay is energised when the input function 'PSP choice bit 2' (see chap. 11.1) is activated.
77	PSP bit 3 selected	The associated output relay is energised when the input function 'PSP choice bit 3' (see chap. 11.1) is activated.
78	El. potentiometer U reset	The corresponding output relay is energised when the input function 'electronic potentiometer U reset' (see chap. 11.1) is activated.
79	El. potentiometer f reset	The corresponding output relay is energised when the input function 'electronic potentiometer f reset' (see chap. 11.1) is activated.
80	Voltage +	The corresponding output relay is energised when the input function 'control pulse voltage +' (see chap. 11.1) is activated.
81	Voltage -	The corresponding output relay is energised when the input function 'control pulse voltage -' (see chap. 11.1) is activated.
82	Frequency +	The corresponding output relay is energised when the input function 'control pulse frequency +' (see chap. 11.1) is activated.
83	Frequency -	The corresponding output relay is energised when the input function 'control pulse frequency -' (see chap. 11.1) is activated.
84	Status relay A1	The corresponding output relay is activated, when the output relay 1 is energised.
85	Status relay A2	The corresponding output relay is activated, when the output relay 2 is energised.
86	Status relay A3	The corresponding output relay is activated, when the output relay 3 is energised.
87	Status relay A4	The corresponding output relay is activated, when the output relay 4 is energised.
88	Status relay A5	The corresponding output relay is activated, when the output relay 5 is energised.
99	Status relay A6	The corresponding output relay is activated, when the output relay 6 is energised.



No.	Function	Description
90	Switching point 1	The corresponding output relay is activated, when the function 'switching point 1' (see <i>chap. 7.11</i> ) has exceeded or undershot the set limit value and the delay time has elapsed.
91	Switching point 2	The corresponding output relay is activated, when the function 'switching point 2' (see <i>chap. 7.11</i> ) has exceeded or undershot the set limit value and the delay time has elapsed.
92	Switching point 3	The corresponding output relay is activated, when the function 'switching point 3' (see <i>chap. 7.11</i> ) has exceeded or undershot the set limit value and the delay time has elapsed.
93	Logic 1	The associated output relay is activated, if the function 'Logic 1' (see <i>chap. 0</i> ) has the output value 'true'.
94	Logic 2	The associated output relay is activated, if the function 'Logic 2' (see <i>chap. 0</i> ) has the output value 'true'.
95	Logic 3	The associated output relay is activated, if the function 'Logic 3' (see <i>chap. 0</i> ) has the output value 'true'.
96	Logic 4	The associated output relay is activated, if the function 'Logic 4' (see <i>chap. 0</i> ) has the output value 'true'.
97	Logic 5	The associated output relay is activated, if the function 'Logic 5' (see <i>chap. 0</i> ) has the output value 'true'.
98	Timer 1	The associated output relay is activated, if the function 'Timer 1' (see <i>chap. 0</i> ) has the output value 'true'.
99	Timer 2	The associated output relay is activated, if the function 'Timer 2' (see <i>chap. 0</i> ) has the output value 'true'.
100	SYN Pulse	The corresponding output relay behaves as a SYN pulse relay according to the configuration.
101	Locking relay	The corresponding output relay behaves as a blocking relay according to the configuration.

## 12.2 Analogue Outputs (optionally)

The KSY 3xx is optionally available with two 0(2) ... 10 V analogue outputs, which can be assigned to various functions. Analogue output 1 is parameterisable via KuPa010 as 0(4) ... 20 mA current output.

**Function:** A function, as described in the table below, can be assigned to the analogue output.

**Working area:** This option defines the limits of the analogue output. The following settings are available:

- 0 ... 10 V
- 2 ... 10 V
- 0 ... max. 10 V
- 2 ... max. 10 V
- 0 ... 20 mA (only analogue output 1)
- 2 ... 20 mA (only analogue output 1)
- 0 ... max. 20 mA (only analogue output 1)
- 2 ... max. 20 mA (only analogue output 1)

**Start value:** Specifies, at which percentage amount of the functional variable, the start value of the analogue output (0/2 V or 0/4 mA at xx% of the function variable).

**End value:** Specifies, at which percentage amount of the functional variable, the end value of the analogue output (0/2 V or 0/4 mA at xx% of the function variable).

**Offset:** This value is only active and accessible when the PID function is selected. The analog output is raised by the set offset (the offset so is added to the output value of the PID controller). This setting is necessary since the PID controller at a control difference = 0 also supplies an (internal) output signal of 0. The offset allows control in both directions without having to adjust the start and end values.

The reference potential of the two analogue outputs is terminal KL1.

The following functions can be assigned to the analogue outputs:

No.	Function	Description
0	Without Function	The output is not active
1	Mains voltage L1-N	Mains voltage L1 scaled in xx.x % of the nominal voltage.
2	Mains voltage L2-N	Mains voltage L2 scaled in xx.x % of the nominal voltage.
3	Mains voltage L3-N	Mains voltage L3 scaled in xx.x % of the nominal voltage.
4	Mains voltage average L1-N / L2-N / L3-N	Mean value of the mains neutral point voltages in xx.x % of the nominal voltages.
5	Mains voltage L1-L2	Mains voltage L1-L2 scaled in xx.x % of the nominal voltage.
6	Mains voltage L2-L3	Mains voltage L2-L3 scaled in xx.x % of the nominal voltage.

No.	Function	Description
7	Mains voltage L3-L1	Mains voltage L3-L1 scaled in xx.x % of the nominal voltage.
8	Mains voltage average L12 / L23 / L31	Mean value of the mains external conductors in xx.x % of the nominal voltage.
9	Generator voltage L1-N	Generator voltage L1 scaled in xx.x % of the nominal voltage.
10	Generator voltage L2-N	Generator voltage L2 scaled in xx.x % of the nominal voltage.
11	Generator voltage L3-N	Generator voltage L3 scaled in xx.x % of the nominal voltage.
12	Generator voltage average L1-N / L2-N / L3-N	Mean value of the generator neutral point voltages in xx.x % of the nominal voltages.
13	Generator voltage L1-L2	Generator voltage L1-L2 scaled in xx.x % of the nominal voltage.
14	Generator voltage L2-L3	Generator voltage L2-L3 scaled in xx.x % of the nominal value.
15	Generator voltage L3-L1	Generator voltage L3-L1 scaled in xx.x % of the nominal value.
16	Generator voltage average L12 / L23 / L31	Mean value of the generator external conductor voltages in xx.x % of the nominal voltages.
17	Mains frequency L1	Mains frequency L1 scaled in xxx.xx Hz.
18	Generator frequency L1	Generator frequency L1 scaled in xxx.xx Hz.
19	Electronic potentiometer voltage	The analogue output emits the value of the electronic potentiometer voltage.
20	Electronic potentiometer frequency	The analogue output emits the value of the electronic potentiometer frequency.
21	PID-T1 controller voltage	The analogue output emits the value of PID-T1 controller voltage.
22	PID-T1 controller voltage	The analogue output emits the value of PID-T1 controller frequency.

## 13 Logic Functions

The KSY 3xx is equipped with programmable logic modules. The following functions are available:

- AND gate
- OR gate
- Exclusive OR gate
- AND Not gate
- OR Not gate
- Exclusive Not OR gate
- Timer pick up delayed
- Timer drop out delayed

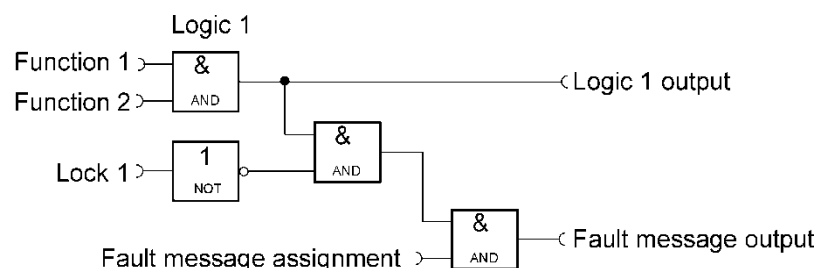

All logic and timer functions can be assigned to the fault message groups and to the collective fault. The available blocking functions are also available for all logic and timer functions. Each input function is invertible.

For all logic and timer functions, the digital output functions (see *chap. 12.1 - Digital Outputs*) are available as input functions.

### 13.1 Output Logic Function on Digital Input Function

Each (virtual) output of the logic gates can be linked to an input function. The input function is then activated either via the digital input (if assigned) or via the output of the logic function.

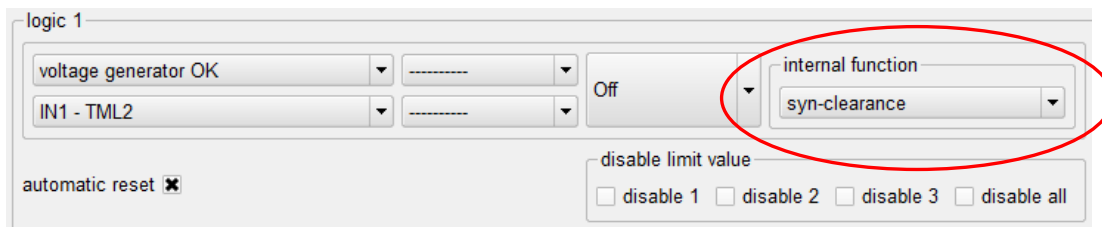

In the example shown above, the output of the function 'Logic 1' is linked to the input function 'SYN enable'.

The input function 'SYN clearance' is activated via the output of the function 'Logic 1', if both, the digital output function 'Voltage generator OK' and the digital input E1 are activated.

### 13.2 AND – Gate (1)

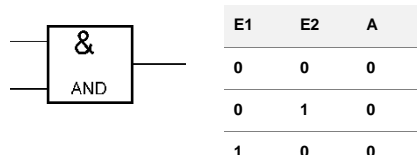

2 parameterisable inputs are logical AND linked.

### 13.3 OR – Gate (2)

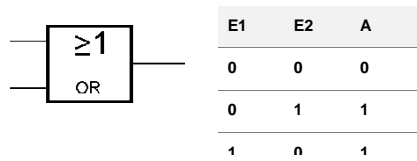

2 parameterisable inputs are logical OR linked.

### 13.4 Exclusive OR – Gate (3)

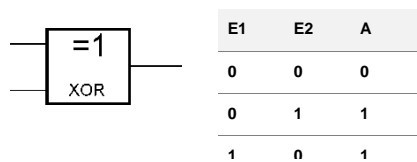

2 parameterisable inputs are logical EXCLUSIVE OR linked.

### 13.5 AND-Not – Gate (4)

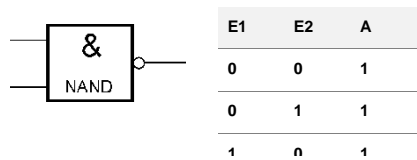

2 parameterisable inputs are logical AND NOT linked.

### 13.6 OR-Not – Gate (5)

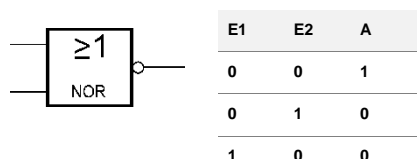

2 parameterisable inputs are logical OR NOT linked.

### 13.7 Exclusive Not-OR – Gate (6)

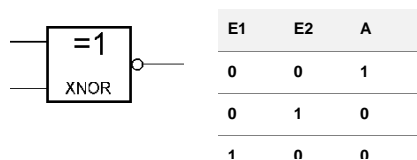

2 parameterisable inputs are logical EXCLUSIVE NOT OR linked.

### 13.8 Timer pick up delayed

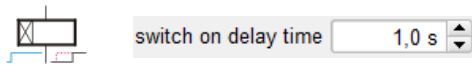

figured left: 1,0 s).

If the input signal is active, the output of the timer only switches after the set delay time has elapsed (*example*

### 13.9 Timer drop down delayed

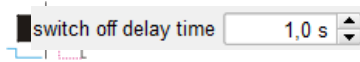

After drop out of the input signal, the output of the timer switches off only after the set delay time has elapsed (example figured left: 1,0 s).

### 13.10 Fault Message Assignment

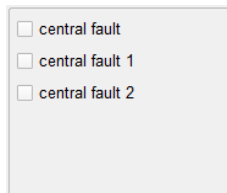

All logic and timer functions can be individually assigned to the 'collective fault', 'collective fault 1', 'collective fault 2' and the fault message groups U, I, F, and P.

### 13.11 Locking Functions and Auto Reset

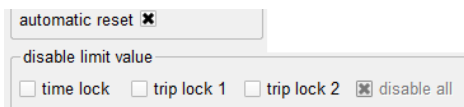

For all logic and timer functions, the fault messaging behavior can be set to auto-reset and the available Locking functions can be activated in order to suppress a fault message if necessary. The logic and timer functions

are executed independently of this.

## 14 Technical Data



**Assembly and putting into operation only by trained professionals**  
**Connecting in compliance with VDE 0160**

<b>Auxiliary voltage (operating voltage)</b>	- 24 V DC (18 – 36 V) - 230 V AC / 50 Hz (180 – 265 V)
<b>Power consumption</b>	approx. 4 W at 24 V DC approx. 6 VA at 230 V AC
<b>Digital inputs</b>	LowActive contact voltage 12 V DC, 5 mA, opto-decoupled), cables not longer than 3 m.
<b>Relay outputs</b>	230 V / 50 Hz / 2 A (potential free) - 1 neutral changeover contact (A5) - 1 neutral normally open contact (A6) - 4 normally open contacts with common root (A1 – A4)
<b>Analogue outputs (optionally)</b>	0 ... 10 V DC +/- 0.05 V max. 10.5 V 0 ... 20 mA +/- 0.1 mA max. 21 mA $R_{Load} \geq 1 \text{ k}\Omega$ (voltage output) / $R_{Load} \leq 400 \Omega$ (current output)
<b>Measuring range voltage</b>	approx. 20 up to 280 / 480 V AC, class 0.2 tolerance < 0,1 % of end value (270 / 480 V AC)
<b>Measuring range frequency</b>	15.0 Hz up to 100.0 Hz starts with approx. 10 V L-N / adjustable in 0.01 Hz steps, repeat accuracy < 0.01 Hz
<b>Climatic conditions: Ambient temperature in operation</b>	according to DIN EN 60255-1 (09-2010)
<b>transport and storage</b>	-20 °C ... +55 °C -25 °C ... +55 °C
<b>Housing</b>	top-hat rail mounting 35 mm (DIN EN 60715) dimensions: W / H / D: 100 x 75 x 110 mm

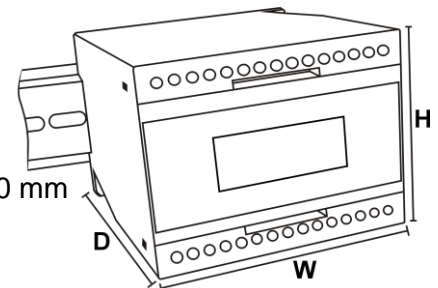

## 14.1 Triggering Values

	Setting range	Resolution	Repeatability	Minimum triggering delay
<b>Over- / Undervoltage</b>	10 up to 199 % nominal voltage	0.1 %	< 0.1 %	< 60 ms, typ. 48 ms
<b>Over- / Underfrequency</b>	35.0 ... 65.0 Hz	0.01 Hz	< 0.01 Hz	< 60 ms, typ. 48 ms
<b>Vector shift</b>	5 ... 45°	0.1°	0.2°	60 ... 80 ms

## 14.2 Ordering Information

Synchroniser Relay KSY 3xx	Part number
----------------------------	-------------

KSY 340 100/400 V / 24 V DC with analogue output	2W300S0000
--	------------

Accessories	
-------------	--

Parameterisation cable USB A: USB Mini 1,5 m	on request
Parameterisation cable USB A: USB Mini 3,0 m	on request



# 15 Connection Diagram

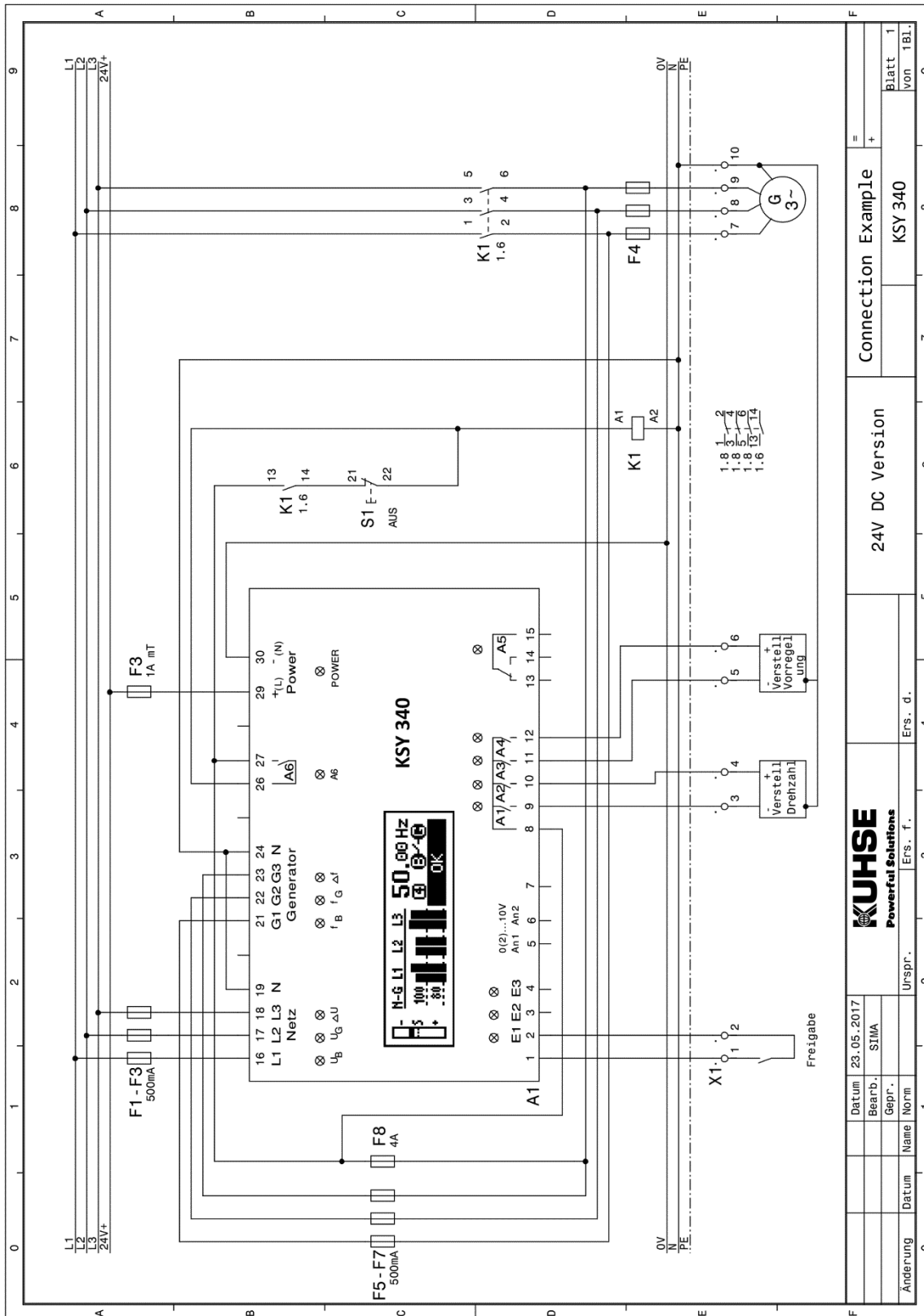

## 16 Parameter Groups

### 16.1 Configuration (Konfig. / Config – Group 1)

The parameter group 1 contains two parameters per subgroup (*refer to chap. 6.6*). The following settings are available:

Parameter		Description	Setting range	Default
1.6.1	PIN protection	4-digit PIN Code	0001 ... 9999	0001
1.6.2		activating of input PIN protection	1 / 0 (on / off)	off (0)
1.9.1	Nominal voltage	Nominal voltage of the plant in xxxxxx.x Volt (conductor voltage at 3-wire systems;	50.0 ... 99,999.9 V	230.9 V
1.9.2		string voltage at 3-wire+N systems) without function	-	0
1.12.1	Nominal frequency	Nominal frequency of the plant, 50 or 60 Hz	0 / 255 (50 / 60 Hz)	50 Hz (0)
1.12.2		without function	-	0
1.13.1	Primary voltage mains	Mains primary voltage of the plant in xxxxxx Volt	1 ... 100,000 V	231 V
1.13.2		without function	-	0
1.14.1	Secondary voltage mains	Mains secondary voltage of the plant in xxxxxx Volt	1 ... 100,000 V	231 V
1.14.2		without function	-	0
1.15.1	Kind of grid	3-wire system or 3-wire+N (4-wire-) system	0 / 255 (3- / 4-LN)	3-LN (0)
1.15.2		without function	-	0
1.16.1	First error display	Activating of first error display only ( <i>see chap. 7.8.7</i> )	255 / 0 (on / off)	off (0)
1.16.2		without function	-	0
1.17.1	Display format	Displaying of voltage values ( <i>see chap. 6.3</i> )	1 ... 5 (xx.x V - xxx kV)	auto V (0)
1.17.2		without function	-	0
1.18.1	Standard display	Displaying of absolute or relative values	1 / 2 (abs. / rel.)	U-bar (64)
1.18.2		without function	-	0
1.19.1	View reset time	Switching back to standard display in x sec.	0 ... 600 sec.	60 sec.
1.19.2		without function	-	0
1.20.1	Brightness max.	Maximum brightness of the lighting in %	50 ... 100 %	100 %
1.20.2		without function	-	0

Parameter		Description	Setting range	Default
1.21.1 1.21.2	Brightness min.	Minimum brightness of the lighting in % without function	0 ... 50 %	10 %
			-	0
1.22.1 1.22.2	Screensaver time	Time until activating brightness min. in x sec. without function	0 ... 600 sec.	60 sec.
			-	0
1.23.1 1.23.2	Analogue output	Activating of functions for analogue output (required for devices with analogue output!) without function	255 / 0 (on / off)	off (0)
			-	0
1.25.1 1.25.2	Primary voltage generator	Plant primary voltage of the generator (for all PSP) in xxxxxx Volt without function	1 ... 100,000 V	231 V
			-	0
1.26.1 1.26.2	Secondary voltage generator PSP 1	Plant secondary voltage of the generator for PSP 1 in xxxxxx Volt without function	1 ... 100,000 V	231 V
			-	0
1.27.1 1.27.2	Secondary voltage generator PSP 2	Plant secondary voltage of the generator for PSP 2 in xxxxxx Volt without function	1 ... 100,000 V	400 V
			-	0
1.28.1 1.28.2	Secondary voltage generator PSP 3	Plant secondary voltage of the generator for PSP 3 in xxxxxx Volt without function	1 ... 100,000 V	400 V
			-	0
1.29.1 1.29.2	Secondary voltage generator PSP 4	Plant secondary voltage of the generator for PSP 4 in xxxxxx Volt without function	1 ... 100.000 V	400 V
			-	0
1.33.1 1.33.2	Number of PSP	Number of deployed parallel switching points	1 ... 4	1

## 16.2 Limit Values (Grenzwerte / Limits – Group 4)

The parameter group 4 contains four parameters per subgroup (*refer to chap. 6.6*). The following settings are available:

Parameter		Description	Setting range	Default
4.1.1	Under-voltage mains	Trigger switching point in xx.x %	10.0 ... 199.9 %	90.0 %
4.1.2		Switch-back Hysteresis in xx.x %	0.5 ... 50.0 %	0.5 %
4.1.3		Triggering delay in xx.xx sec.	0.05 ... 999.99 sec.	0.05 sec.
4.1.6		Coding of fault message behaviour	(see chap. 6.6.3)	activated / auto-reset (100000000001001)
4.2.1	Overvoltage mains	Trigger switching point in xx.x %	10.0 ... 199.9 %	110.0 %
4.2.2		Switch-back Hysteresis in xx.x %	0.5 ... 50.0 %	0.5 %
4.2.3		Triggering delay in xx.xx sec.	0.05 ... 999.99 sec.	0.05 sec.
4.2.6		Coding of fault message behaviour	(see chap. 6.6.3)	activated / auto-reset (100000000001001)
4.3.1	Under-voltage generator	Trigger switching point in xx.x %	10.0 ... 199.9 %	80.0 %
4.3.2		Switch-back Hysteresis in xx.x %	0.5 ... 50.0 %	0.5 %
4.3.3		Triggering delay in xx.xx sec.	0.05 ... 999.99 sec.	0.05 sec.
4.3.6		Coding of fault message behaviour	(see chap. 6.6.3)	activated / auto-reset (100000000001001)
4.4.1	Overvoltage generator	Trigger switching point in xx.x %	10.0 ... 199.9 %	115.0 %
4.4.2		Switch-back Hysteresis in xx.x %	0.5 ... 50.0 %	0.5 %
4.4.3		Triggering delay in xx.xx sec.	0.05 ... 999.99 sec.	0.05 sec.
4.4.6		Coding of fault message behaviour	(see chap. 6.6.3)	activated / auto-reset (100000000001001)
4.5.1	Under-frequency mains	Trigger switching point in xx.xx Hz	35.00 ... 75.00 Hz	49.50 Hz
4.5.2		Switch-back Hysteresis in x.xx Hz	0.02 ... 2.00 Hz	0.10 Hz
4.5.3		Triggering delay in xx.xx sec.	0.05 ... 999.99 sec.	0.05 sec.
4.5.6		Coding	(see chap. 6.6.3)	activated / auto-reset (100000000001001)
4.6.1	Over-frequency mains	Trigger switching point in xx.xx Hz	35.00 ... 75.00 Hz	50.05 Hz
4.6.2		Switch-back Hysteresis in x.xx Hz	0.02 ... 2.00 Hz	0.5 Hz
4.6.3		Triggering delay in xx.xx sec.	0.05 ... 999.99 sec.	0.05 sec.
4.6.6		Coding	(see chap. 6.6.3)	activated / auto-reset (100000000001001)
4.7.1	Under-frequency generator	Trigger switching point in xx.xx Hz	35.00 ... 75.00 Hz	47.50 Hz
4.7.2		Switch-back Hysteresis in x.xx Hz	0.02 ... 2.00 Hz	0.50 Hz
4.7.3		Triggering delay in xx.xx sec.	0.05 ... 999.99 sec.	0.05 sec.
4.7.6		Coding	(see chap. 6.6.3)	activated / auto-reset (100000000001001)
4.8.1	Over-frequency generator	Trigger switching point in xx.xx Hz	35.00 ... 75.00 Hz	51.50 Hz
4.8.2		Switch-back Hysteresis in x.xx Hz	0.02 ... 2.00 Hz	0.50 Hz
4.8.3		Triggering delay in xx.xx sec.	0.05 ... 999.99 sec.	0.05 sec.
4.8.6		Coding	(see chap. 6.6.3)	activated / auto-reset (100000000001001)

Parameter		Description	Setting range	Default
4.9.1 4.9.3 4.9.6	Vector shift mains	Trigger switching point in xx.x ° Function (see chap.7.9.7) Coding	5,0 ... 45,0 ° 0 ... 5 (see chap. 7.9.7) (see chap. 6.6.3)	8.0 ° L1+L2+L3 (4) activated / auto-reset (100000000001001)
4.11.1 4.11.3 4.11.6	ROCOF mains	Trigger switching point in x.xx Hz/s Triggering delay in xx.xx sec. Coding	0.01 ... 10.00 Hz/s 0.05 ... 999.99 sec. (see chap. 6.6.3)	0.10 Hz/s 1.00 sec. deactivated (0100100000001001)
4.13.1 4.13.2 4.13.3 4.13.6	Angle mains	Trigger switching point in xxx ° Switch-back Hysteresis in xx ° Triggering delay in xx.xx sec. Coding	1 ... 60 ° 1 ... 20 ° 0.05 ... 999.99 sec. (see chap. 6.6.3)	10 ° 1 ° 1.00 sec. deactivated (0100100000001011)
4.14.1 4.14.2 4.14.3 4.14.6	Angle generator	Trigger switching point in xxx ° Switch-back Hysteresis in xx ° Triggering delay in xx.xx sec. Coding	1 ... 60 ° 1 ... 20 ° 0.05 ... 999.99 sec. (see chap. 6.6.3)	20 ° 1 ° 1.00 sec. deactivated (0100100000001011)
4.15.1 4.15.2 4.15.3 4.15.6	Voltage asymmetry mains	Trigger switching point in xx.x % Switch-back Hysteresis in xx.x % Triggering delay in xx.xx sec. Coding	1.0 ... 100.0 % 0.5 ... 50.0 % 0.05 ... 999.99 sec. (see chap. 6.6.3)	10.0 % 1.0 % 0.05 sec. deactivated (0100100000001011)
4.16.1 4.16.2 4.16.3 4.16.6	Voltage asymmetry generator	Trigger switching point in xx.x % Switch-back Hysteresis in xx.x % Triggering delay in xx.xx sec. Coding	1.0 ... 100.0 % 0.5 ... 50.0 % 0.05 ... 999.99 sec. (see chap. 6.6.3)	10.0 % 1.0 % 0.05 sec. deactivated (0100100000001011)
4.17.1 4.17.6	Rotary field monitoring mains / generator	Rotary field right or left Coding	1 / 0 (left / right) (see chap. 6.6.3)	right (0) activated (1000000000001001))
4.19.1 4.19.2 4.19.3 4.19.6	Voltage quality mains	Trigger switching point in xx.x % Switch-back Hysteresis in xx.x % Triggering delay in xx.xx sec. Coding	110.0 ... 115.0 % 0.5 ... 3.0 % 600 sec. (see chap. 6.6.3)	110.0 % 1.0 % 600 sec. deactivated (0100100000001011)

Parameter		Description	Setting range	Default
4.20.1 4.20.2 4.20.3 4.20.6	Mean value deviation mains	Trigger switching point in xx.x % Switch-back Hysteresis in xx.x % Triggering delay in xx.xx sec. Coding	1.0 ... 100.0 % 0.5 ... 50.0 % 0.05 ... 999.99 sec. (see chap. 6.6.3)	90.0 % 1.0 % 1.00 sec. deactivated (0000100000001011)
4.21.1 4.21.2 4.21.3 4.21.6	Mean value deviation generator	Trigger switching point in xx.x % Switch-back Hysteresis in xx.x % Triggering delay in xx.xx sec. Coding	1.0 ... 100.0 % 0.5 ... 50.0 % 0.05 ... 999.99 sec. (see chap. 6.6.3)	90.0 % 1.0 % 1.00 sec. deactivated (0000100000001011)
4.22.1 4.22.2 4.22.3 4.22.6	Slip	Trigger switching point in xx.xx Hz Switch-back Hysteresis in xx.xx Hz Triggering delay in xx.xx sec. Coding	0.01 ... 50.00 Hz 0.02 ... 2.00 Hz 0.05 ... 999.99 sec. (see chap. 6.6.3)	2.00 Hz 0.02 1.00 sec. deactivated (0100100011110001)
4.23.1 4.23.2 4.23.3 4.23.6	Switching-on voltage	Trigger switching point in xx.x % Switch-back Hysteresis in xx.x % Triggering delay in xx.xx sec. Coding	0.0 ... 150.0 % 0.5 ... 50.0 % 0.05 ... 999.99 s (see chap. 6.6.3)	80.0 % 5.0 % 0.05 s (1001100000111001)
4.24.1 4.24.2 4.24.3 4.24.6	Switching-on frequency	Trigger switching point in xx.xx Hz Switch-back Hysteresis in xx.xx Hz Triggering delay in xx.xx sec. Coding	35.00 ... 75.00 Hz 0.02 ... 2.00 Hz 0.05 ... 999.99 s (see chap. 6.6.3)	48.00 Hz 0.20 Hz 0.05 s (1001100000111001)
4.25.1 4.25.2 4.25.3 4.25.6	Sync pulse monitoring	Trigger switching point in seconds Coding	0 ... 200 s	200 s (1101100000011001)
4.26.1 4.26.2 4.26.3 4.26.6	Release monitoring	Trigger switching point in seconds Coding	0 ... 200 s	200 s (1101100000011001)
4.27.1 4.27.2 4.27.3 4.27.7	Switching point 1	Trigger switching point in xx.x % Switch-back Hysteresis in xx.x % Triggering delay in xx.xx sec. Coding	0.1 ... 199.0 % 0.5 ... 3.0 % 600 sec. (see chap. 6.6.3)	100.0 % 1.0 % 1 sec. 0 (without function)

Parameter		Description	Setting range	Default
4.28.1	Switching point 2	Trigger switching point in xx.x %	0.1 ... 199.0 %	100.0 %
4.28.2		Switch-back Hysteresis in xx.x %	0.5 ... 3.0 %	1.0 %
4.28.3		Triggering delay in xx.xx sec.	600 sec.	1 sec.
4.28.7		Coding	(see chap. 6.6.3)	0 (without function)
4.29.1	Switching point 3	Trigger switching point in xx.x %	0.1 ... 199.0 %	100.0 %
4.29.2		Switch-back Hysteresis in xx.x %	0.5 ... 3.0 %	1.0 %
4.29.3		Triggering delay in xx.xx sec.	600 sec.	1 sec.
4.29.7		Coding	(see chap. 6.6.3)	0 (without function)

### 16.3 Analogue Outputs

Parameter		Description	Setting range	Default
5.1.1	Analogue 1	Function assignment	0 .. 22 (see chap. 12.2)	0 (0 .. 10 V)
5.1.2		Start value (at 0 resp. 2 V)	-150.0 ... 150.0 %	0.0 %
5.1.3		End value (at 10 V)	-150.0 ... 150.0 %	100.0 %
5.1.5		Working range	0 .. 9 (see chap. 12.2) 0.00 ... 10.00 V	0 (without function) 0.00 V
5.2.1	Analogue 2	Function assignment	0 .. 22 (see chap. 12.2)	0 (0 .. 10 V)
5.2.2		Start value (at 0 resp. 2 V)	-150.0 ... 150.0 %	0.0 %
5.2.3		End value (at 10 V)	-150.0 ... 150.0 %	100.0 %
5.2.5		Working range	0 .. 9 (see chap. 12.2) 0.00 ... 10.00 V	0 (without function) 0.00 V

### 16.4 Digital Outputs (Digi. Ausg. / OUT – Group 6)

The parameter group 6 contains three parameters per subgroup (refer to chap. 6.6.2). The following settings are available:

Parameter		Description	Setting range	Default
6.1.1	A1 / Relay 1, terminal KL 9	Function	0 ... 101 (see chap. 12.1)	Pulse voltage - (46)
6.1.2		Switching behaviour	1 / 0 (quiescent- / working current)	Working current (0)
6.1.3		Pulse duration (min.)	0.1 ... 6,000.0 sec.	2.0 sec.
6.2.1	A2 / Relay 2, terminal KL 10	Function	0 ... 101 (see chap. 12.1)	Pulse voltage +(45)
6.2.2		Switching behaviour	1 / 0 (quiescent- / working current)	Working current (0)
6.2.3		Pulse duration (min.)	0.1 ... 6,000.0 sec.	2.0 sec.



Parameter		Description	Setting range	Default
6.3.1 6.3.2 6.3.3	A3 / Relay 3, terminal KL 11	Function Switching behaviour Pulse duration (min.)	0 ... 101 (see chap. 12.1) 1 / 0 (quiescent- / working current) 0.1 ... 6,000.0 sec.	Pulse frequency - (48) Working current (0) 2.0 sec.
6.4.1 6.4.2 6.4.3	A4 / Relay 4, terminal KL 12	Function Switching behaviour Pulse duration (min.)	0 ... 101 (see chap. 12.1) 1 / 0 (quiescent- / working current) 0.1 ... 6,000.0 sec.	Pulse frequency + (47) Working current (0) 2.0 sec.
6.5.1 6.5.2 6.5.3	A5 / Relay 5, term. KL 13- 15	Function Switching behaviour Pulse duration (min.)	0 ... 101 (see chap. 12.1) 1 / 0 (quiescent- / working current) 0.1 ... 6,000.0 sec.	ready for operation (1) Working current (0) 2.0 sec.
6.6.1 6.6.2 6.6.3	A6 / Relay 6, term. KL 26 / 27	Function Switching behaviour Pulse duration (min.)	0 ... 101 (see chap. 12.1) 1 / 0 (quiescent- / working current) 0.1 ... 6,000.0 sec.	Sync pulse (100) Working current (0) 2.0 sec.

## 16.5 Digital Inputs (Digi. Eing. / IN – Group 7)

The parameter group 7 contains two parameters per subgroup (refer to chap. 6.6.2). The following settings are available:

Parameter		Description	Setting range	Default
7.1.1 7.1.2	E1 / terminal KL 2	Function Switching behaviour	0 .. 40 (see chap. 11.1) 1 / 0 (quiescent- / working current)	SYN clearance (20) working current (0)
7.1.1 7.1.2	E2 / terminal KL 3	Function Switching behaviour	0 .. 40 (see chap. 11.1) 1 / 0 (quiescent- / working current)	Isolated operation (21) working current (0)
7.1.1 7.1.2	E3 / terminal KL 4	Function Switching behaviour	0 .. 40 (see chap. 11.1) 1 / 0 (quiescent- / working current)	Error reset (5) working current (0)



## 16.6 Logic Functions (Logik – Group 10)

The parameter group 10 contains six respectively five parameters per subgroup (refer to chap. 6.6.2). The following settings are available:

Parameter	Description	Setting range	Default
11.1.1	Logic 1	Function E1	0 (without Function)
11.1.2		1 / 0 (inverted / normally)	0 (normally)
11.1.3		Function E2	0 (without Function)
11.1.4		1 / 0 (inverted / normally)	0 (normally)
11.1.5		Logic function	0 (without Function)
11.1.7		Coding of fault message	auto reset
11.1.8		behaviour	(1000000000001000)
	Internal assignment	0 ... 15 (see chap. 11.1)	0
11.2.1	Logic 2	Function E1	0 (without Function)
11.2.2		1 / 0 (inverted / normally)	0 (normally)
11.2.3		Function E2	0 (without Function)
11.2.4		1 / 0 (inverted / normally)	0 (normally)
11.2.5		Logic function	0 (without Function)
11.2.7		Coding of fault message	auto reset
11.2.8		behaviour	(1000000000001000)
	Internal assignment	0 ... 15 (see chap. 11.1)	0
11.3.1	Logic 3	Function E1	0 (without Function)
11.3.2		1 / 0 (inverted / normally)	0 (normally)
11.3.3		Function E2	0 (without Function)
11.3.4		1 / 0 (inverted / normally)	0 (normally)
11.3.5		Logic function	0 (without Function)
11.3.7		Coding of fault message	auto reset
11.3.8		behaviour	(1000000000001000)
	Internal assignment	0 ... 15 (see chap. 11.1)	0
11.4.1	Logic 4	Function E1	0 (without Function)
11.4.2		1 / 0 (inverted / normally)	0 (normally)
11.4.3		Function E2	0 (without Function)
11.4.4		1 / 0 (inverted / normally)	0 (normally)
11.4.5		Logic function	0 (without Function)
11.4.7		Coding of fault message	auto reset
11.4.8		behaviour	(1000000000001000)
	Internal assignment	0 ... 15 (see chap. 11.1)	0
11.5.1	Logic 5	Function E1	0 (without Function)
11.5.2		1 / 0 (inverted / normally)	0 (normally)
11.5.3		Function E2	0 (without Function)

Parameter	Description	Setting range	Default
11.5.4	1 / 0 (inverted / normally)	0 or 1	0 (normally)
11.5.5	Logic function	0 ... 6 (see chap. 13)	0 (without Function)
11.5.7	Coding of fault message	(see chap. 6.6.3)	auto reset
11.5.8	behaviour		(1000000000001000)
	Internal assignment	0 ... 15 (see chap. 11.1)	0
11.6.1	Function input	0 ... 47 (see chap. 11.1)	0 (without Function)
11.6.2	1 / 0 (inverted / normally)	0 or 1	0 (normally)
11.6.5	Timer function (pick-up/drop-out delay)	0 or 1 (see chap. 13)	1 (pick-up delay)
11.6.6	Timer duration	0 ... 6,000,0 sec.	1.0 sec.
11.6.7	Coding of fault message	(see chap. 6.6.3)	auto reset
11.6.8	behaviour		(1000100000001000)
	Internal assignment	0 ... 15 (see chap. 11.1)	0
11.7.1	Function input	0 ... 47 (see chap. 11.1)	0 (without Function)
11.7.2	1 / 0 (inverted / normally)	0 or 1	0 (normally)
11.7.5	Timer function (pick-up/drop-out delay)	0 or 1 (see chap. 13)	1 (pick-up delay)
11.7.6	Timer duration	0 ... 6,000,0 sec.	1.0 sec.
11.7.7	Coding of fault message	(see chap. 6.6.3)	auto reset
11.7.8	behaviour		(1000100000001000)
	Internal assignment	0 ... 15 (see chap. 11.1)	0

## 16.7 Syn (SYN – Group 11)

Parameter		Description	Setting range	Default
11.3.1	Syn Delta Umax PSP1	Syn delta maximum voltage	0.0 ... 150.0 %	4.0 %
11.4.1	Target pt. freq. PSP1	Target point of frequency regulation	0.01 ... 15.00 Hz	0.15 Hz
11.5.1	Syn Delta fmax PSP1	Syn delta maximum frequency	0.2 ... 15.00 Hz	0.30 Hz
11.6.1	Syn Pulse Duration PSP1	Duration of the sync impulse	0.0 ... 100.0 s	1.0 s
11.7.1	Syn Delay Time PSP1	Time delay for the sync clearance	1 ... 25 s	2 s
11.8.1	Syn Lead Time PSP1	Lead time for the sync impulse	0 ... 1000 ms	100 ms
11.9.1	Syn Integ. Time Freq PSP1	Sync integrating time for frequency	1 ... 100 periods	5 per.
11.10.1	Block Delta Umax PSP1	Locking delta maximum voltage	0.0 ... 15 %	5 %
11.11.1	Block Delta fmax PSP1	Locking delta maximum frequency	0.01 ... 1.00 Hz	0.50 Hz
11.11.1	Block Delta Phi max PSP1	Locking delta phi maximum	0 ... 30°	10°
11.12.1 11.12.2	Isolated Operation Nominal Voltage PSP1	Nominal voltage isolated operation Deviating nominal voltage	0 ... 150 % 0 (no) / 255 (yes)	100 % no (0)
11.13.1 11.13.2	Isolated Operation Nominal Frequency PSP1	Nominal frequency Isolated mode Deviating nominal frequency	30 ... 75 Hz 0 (no) / 255 (yes)	50 Hz no (0)
11.18.1	Syn Delta Umax PSP2	Syn delta maximum voltage	0.0 ... 150.0 %	4.0 %
11.19.1 11.19.2	Target pt. freq. PSP2	Target point of frequency regulation Frequency deviating from PSP 1	0.01 ... 15.00 Hz 0 (no) / 255 (yes)	0.15 Hz no (0)
11.20.1	Syn Delta fmax PSP2	Syn delta maximum frequency	0.20 ... 15.00 Hz	0.30 Hz

Parameter		Description	Setting range	Default
11.21.1 11.21.2	Syn Pulse Duration PSP2	Duration of the sync impulse Time deviating from PSP 1	0.0 ... 100.0 s 0 (no) / 255 (yes)	1.0 s no (0)
11.22.1	Syn Delay Time PSP2	Time delay for the sync clearance	1 ... 25 s	2 s
11.23.1	Syn Lead Time PSP2	Lead time for the sync impulse	0 ... 1000 ms	100 ms
11.24.1	Syn Integ. Time Freq PSP2	Sync integrating time for frequency	1 ... 100 periods	5 per.
11.25.1 11.25.2	Block Delta Umax PSP2	Locking delta maximum voltage Deviating from PSP 1	0.0 ... 15.0 % 0 (no) / 255 (yes)	5.0 % no (0)
11.26.1 11.26.2	Block Delta fmax PSP2	Locking delta maximum frequency Deviating from PSP 1	0.01 ... 1.00 Hz 0 (no) / 255 (yes)	0.50 Hz no (0)
11.27.1 11.27.2	Block Delta Phi max PSP2	Locking delta phi maximum Deviating from von PSP 1	0 ... 30° 0 (no) / 255 (yes)	10° no (0)
11.28.1 11.28.2	Isolated Operation Nominal Voltage PSP2	Nominal voltage for isolated mode Deviating from nominal voltage	0 ... 150 % 0 (no) / 255 (yes)	100 % no (0)
11.29.1 11.29.2	Isolated Operation Nominal Frequency PSP2	Nominal frequency for Isolated mode operation Deviating from nominal frequency	30 ... 75 Hz 0 (no) / 255 (yes)	50 Hz no (0)
11.33.1	Syn Delta Umax PSP3	Syn delta maximum voltage	0.0 ... 150.0 %	4.0 %
11.34.1 11.34.2	Target pt. freq. PSP3	Target point of frequency regulation Frequency deviating from PSP 1	0.01 ... 15.00 Hz 0 (no) / 255 (yes)	0.15 Hz no (0)
11.35.1	Syn Delta fmax PSP3	Syn delta maximum frequency	0.20 ... 15.00 Hz	0.30 Hz
11.36.1 11.36.2	Syn Pulse Duration PSP3	Duration of the sync impulse Time deviating from PSP 1	0.0 ... 100.0 s 0 (no) / 255 (yes)	1.0 s no (0)
11.37.1	Syn Delay Time PSP3	Time delay for the sync clearance	1 ... 25 s	2 s

Parameter		Description	Setting range	Default
11.38.1	Syn Lead Time PSP3	Lead time for the sync impulse	0 ... 1000 ms	100 ms
11.39.1	Syn Integ. Time Freq PSP3	Sync integrating time for frequency	1 ... 100 periods	5 per.
11.40.1 11.40.2	Block Delta Umax PSP3	Locking delta maximum voltage Deviating from PSP 1	0.0 ... 15.0 % 0 (no) / 255 (yes)	5.0 % no (0)
11.41.1 11.41.2	Block Delta fmax PSP3	Locking delta maximum frequency Deviating from PSP 1	0.01 ... 1.00 Hz 0 (no) / 255 (yes)	0.50 Hz no (0)
11.42.1 11.42.2	Block Delta Phi max PSP3	Locking delta phi maximum Deviating from von PSP 1	0 ... 30° 0 (no) / 255 (yes)	10° no (0)
11.43.1 11.43.2	Isolated Operation Nominal Voltage PSP3	Nominal voltage isolated mode Deviating nominal voltage	0 ... 150 % 0 (no) / 255 (yes)	100 % no (0)
11.44.1 11.44.2	Isolated Operation Nominal Frequency PSP3	Nominal frequency isolated mode Deviating nominal frequency	30 ... 75 Hz 0 (no) / 255 (yes)	50 Hz no (0)
11.48.1	Syn Delta Umax PSP4	Syn delta maximum voltage	0.0 ... 150.0 %	4.0 %
11.49.1 11.49.2	Target pt. freq. PSP4	Target point of frequency regulation Frequency deviating from PSP 1	0.01 ... 15.00 Hz 0 (no) / 255 (yes)	0.15 Hz no (0)
11.50.1	Syn Delta fmax PSP4	Syn delta maximum frequency	0.20 ... 15.00 Hz	0.30 Hz
11.51.1 11.51.2	Syn Pulse Duration PSP4	Duration of the sync impulse Time deviating from PSP 1	0.0 ... 100.0 s 0 (no) / 255 (yes)	1.0 s no (0)
11.52.1	Syn Delay Time PSP4	Time delay for the sync clearance	1 ... 25 s	2 s
11.53.1	Syn Lead Time PSP4	Lead time for the sync impulse	0 ... 1000 ms	100 ms
11.54.1	Syn Integ. Time Freq PSP4	Sync integrating time for frequency	1 ... 100 periods	5 per.

Parameter		Description	Setting range	Default
<b>11.55.1</b> <b>11.55.2</b>	Block Delta Umax PSP4	Locking delta maximum voltage Deviating from PSP 1	0.0 ... 15.0 % 0 (no) / 255 (yes)	5.0 % no (0)
<b>11.56.1</b> <b>11.56.2</b>	Block Delta fmax PSP4	Locking delta maximum frequency Deviating from PSP 1	0.01 ... 1.00 Hz 0 (no) / 255 (yes)	0.50 Hz no (0)
<b>11.57.1</b> <b>11.57.2</b>	Block Delta Phi max PSP4	Locking delta phi maximum Deviating from von PSP 1	0 ... 30° 0 (no) / 255 (yes)	10° no (0)
<b>11.58.1</b> <b>11.58.2</b>	Isolated Operation Nominal Voltage PSP4	Nominal voltage isolated mode Deviating nominal voltage	0 ... 150 % 0 (no) / 255 (yes)	100 % no (0)
<b>11.59.1</b> <b>11.59.2</b>	Isolated Operation Nominal Frequency PSP4	Nominal frequency isolated mode Deviating nominal frequency	30 ... 75 Hz 0 (no) / 255 (yes)	50 Hz no (0)

## 16.8 PID-T1-, Pulse Controller and Electronic Potentiometers (Regler – Group 12)

The parameter group 12 contains up to eight parameters per subgroup (*refer to chap. 6.6.2*). The following settings are available:

Parameter	Description	Setting range	Default	
<b>12.2.2</b>	PID voltage isolated / global PSP1	Delay time	0.0 ... 600.0	0.5 sec.
<b>12.2.3</b>		Ramp time	0.0 ... 600.0	0.0 sec.
<b>12.2.4</b>		Dead zone	0.0 ... 50.0 %	1.0 %
<b>12.2.5</b>		Amplification (Kp)	0.01 ... 99.99	0.10
<b>12.2.6</b>		Integration time (Tn)	0.0 ... 999.9 sec.	0.5 sec.
<b>12.2.7</b>		Derivative time (Tv)	0.0 ... 99.9 sec.	0.0 sec.
<b>12.2.8</b>		Reset time (T1)	0.0 ... 99.9 sec.	0.0 sec.
<b>12.2.10</b>		global / operating mode depended	0 (OM depended) / 255 (global)	255
<b>12.3.2</b>	PID frequency isolated / global PSP1	Delay time	0.0 ... 600.0	0.5 sec.
<b>12.3.3</b>		Ramp time	0.0 ... 600.0	0.0 sec.
<b>12.3.4</b>		Dead zone	0.0 ... 50.0 %	1.0 %
<b>12.3.5</b>		Amplification (Kp)	0.01 ... 99.99	0.10
<b>12.3.6</b>		Integration time (Tn)	0.0 ... 999.9 sec.	0.5 sec.
<b>12.3.7</b>		Derivative time (Tv)	0.0 ... 99.9 sec.	0.0 sec.
<b>12.3.8</b>		Reset time (T1)	0.0 ... 99.9 sec.	0.0 sec.
<b>12.3.10</b>		global / operating mode depended	0 (OM depended) / 255 (global)	255
<b>12.4.2</b>	PID voltage SYN PSP1	Delay time	0.0 ... 600.0	0.5 sec.
<b>12.4.3</b>		Ramp time	0.0 ... 600.0	0.0 sec.
<b>12.4.4</b>		Dead zone	0.0 ... 50.0 %	1.0 %
<b>12.4.5</b>		Amplification (Kp)	0.01 ... 99.99	0.10
<b>12.4.6</b>		Integration time (Tn)	0.0 ... 999.9 sec.	0.5 sec.
<b>12.4.7</b>		Derivative time (Tv)	0.0 ... 99.9 sec.	0.0 sec.
<b>12.4.8</b>		Reset time (T1)	0.0 ... 99.9 sec.	0.0 sec.
<b>12.4.10</b>		global / operating mode depended	0 (OM depended) / 255 (global)	255
<b>12.5.2</b>	PID Frequency SYN PSP1	Delay time	0.0 ... 600.0	0.5 sec.
<b>12.5.3</b>		Ramp time	0.0 ... 600.0	0.0 sec.
<b>12.5.4</b>		Dead zone	0.0 ... 50.0 %	0.1 %
<b>12.5.5</b>		Amplification (Kp)	0.01 ... 99.99	0.10
<b>12.5.6</b>		Integration time (Tn)	0.0 ... 999.9 sec.	0.5 sec.
<b>12.5.7</b>		Derivative time (Tv)	0.0 ... 99.9 sec.	0.0 sec.
<b>12.5.8</b>		Reset time (T1)	0.0 ... 99.9 sec.	0.0 sec.
<b>12:5.10</b>		global / operating mode depended	0 (OM depended) / 255 (global)	255

Parameter	Description	Setting range	Default
<b>12.6.2</b>	PID voltage mains parallel PSP1	Delay time	0.0 ... 600.0
<b>12.6.3</b>		Ramp time	0.0 ... 600.0
<b>12.6.4</b>		Dead zone	0.0 ... 50.0 %
<b>12.6.5</b>		Amplification (Kp)	0.01 ... 99.99
<b>12.6.6</b>		Integration time (Tn)	0.0 ... 999.9 sec.
<b>12.6.7</b>		Derivative time (Tv)	0.0 ... 99.9 sec.
<b>12.6.8</b>		Reset time (T1)	0.0 ... 99.9 sec.
<b>12.6.10</b>		global / operating mode depended	0 (OM depended) / 255 (global)
<b>12.7.2</b>	PID Frequency mains parallel PSP1	Delay time	0.0 ... 600.0
<b>12.7.3</b>		Ramp time	0.0 ... 600.0
<b>12.7.4</b>		Dead zone	0.0 ... 50.0 %
<b>12.7.5</b>		Amplification (Kp)	0.01 ... 99.99
<b>12.7.6</b>		Integration time (Tn)	0.0 ... 999.9 sec.
<b>12.7.7</b>		Derivative time (Tv)	0.0 ... 99.9 sec.
<b>12.7.8</b>		Reset time (T1)	0.0 ... 99.9 sec.
<b>12.7.10</b>		global / operating mode depended	0 (OM depended) / 255 (global)
<b>12.8.2</b>	IMP voltage isolated / global PSP1	Release delay time	0.0 ... 600.0
<b>12.8.3</b>		Modulation	0 (PWM) / 1 (PFM)
<b>12.8.4</b>		Dead zone	0.0 ... 50.0 %
<b>12.8.5</b>		Amplify (pulse / % / pulse / per.)	0.01 ... 99.99
<b>12.8.6</b>		0.1 ... 999.9 sec.	0.1 sec.
<b>12.8.10</b>		Pulse duration / period duration global / operating mode depended	0 (OM depended) / 255 (global)
<b>12.9.2</b>	IMP frequency isolated / global PSP1	Release delay time	0.0 ... 600.0
<b>12.9.3</b>		Modulation	0 (PWM) / 1 (PFM)
<b>12.9.4</b>		Dead zone	0.0 ... 50.0 %
<b>12.9.5</b>		Amplify (pulse / % / pulse / per.)	0.01 ... 99.99
<b>12.9.6</b>		0.1 ... 999.9 sec.	0.1 sec.
<b>12.9.10</b>		Pulse duration / period duration global / operating mode depended	0 (OM depended) / 255 (global)
<b>12.10.2</b>	IMP voltage SYN PSP1	Release delay time	0.0 ... 600.0
<b>12.10.3</b>		Modulation	0 (PWM) / 1 (PFM)
<b>12.10.4</b>		Dead zone	0.0 ... 50.0 %
<b>12.10.5</b>		Amplify (pulse / % / pulse / per.)	0.01 ... 99.99
<b>12.10.6</b>		0.1 ... 999.9 sec.	0.1 sec.
		Pulse duration / period duration	



Parameter	Description	Setting range	Default	
12.11.2 12.11.3 12.11.4 12.11.5 12.11.6	IMP frequency SYN PSP1	Release delay time Modulation Dead zone Amplify (pulse / % / pulse / per.) Pulse duration / period duration	0.0 ... 600.0 0 (PWM) / 1 (PFM) 0.0 ... 50.0 % 0.01 ... 99.99 0.1 ... 999.9 sec.	0.5 sec. 1 0.1 % 0.50 sec. 0.1 sec.
12.12.2 12.12.3 12.12.4 12.12.5 12.12.6	IMP voltage mains parallel PSP1	Release delay time Modulation Dead zone Amplify (pulse / % / pulse / per.) Pulse duration / period duration	0.0 ... 600.0 0 (PWM) / 1 (PFM) 0.0 ... 50.0 % 0.01 ... 99.99 0.1 ... 999.9 sec.	0.5 sec. 1 1.0 % 0.50 sec. 0.1 sec.
12.13.2 12.13.3 12.13.4 12.13.5 12.13.6	IMP frequency mains parallel I PSP1	Release delay time Modulation Dead zone Amplify (pulse / % / pulse / per.) Pulse duration / period duration	0.0 ... 600.0 0 (PWM) / 1 (PFM) 0.0 ... 50.0 % 0.01 ... 99.99 0.1 ... 999.9 sec.	0.5 sec. 1 0.1 % 0.50 sec. 0.1 sec.
12.14.3 12.14.5 12.14.6 12.14.10	Electronic potentiometer Voltage isolated / global PSP1	Ramp Swing Offset global / operating mode depended	0.1 ... 250.0 s 0.01 ... 10.00 V 0.00 ... 10.00 V 0 (OM depended) / 255 (global)	10.0 s 5.00 V 5.00 V 255
12.15.3 12.15.5 12.15.6 12.15.10	Electronic potentiometer Frequency isolated / global PSP1	Ramp Swing Offset global / operating mode depended	0.1 ... 250.0 s 0.01 ... 10.00 V 0.00 ... 10.00 V 0 (OM depended) / 255 (global)	10.0 s 5.00 V 5.00 V 255
12.16.3 12.16.5 12.16.6	Electronic potentiometer Voltage SYN PSP1	Ramp Swing Offset	0.1 ... 250.0 s 0.01 ... 10.00 V 0.00 ... 10.00 V	10.0 s 5.00 V 5.00 V
12.17.3 12.17.5 12.17.6	Electronic potentiometer Frequency SYN PSP1	Ramp Swing Offset	0.1 ... 250.0 s 0.01 ... 10.00 V 0.00 ... 10.00 V	10.0 s 5.00 V 5.00 V

Parameter	Description	Description	Setting range	Default
<b>12.18.3</b>	Electronic potentiometer Voltage mains parallel PSP1	Ramp	0.1 ... 250.0 s	10.0 s
<b>12.18.5</b>		Swing	0.01 ... 10.00 V	5.00 V
<b>12.18.6</b>		Offset	0.00 ... 10.00 V	5.00 V
<b>12.19.3</b>	Electronic potentiometer Frequency mains parallel PSP1	Ramp	0.1 ... 250.0 s	10.0 s
<b>12.19.5</b>		Swing	0.01 ... 10.00 V	5.00 V
<b>12.19.6</b>		Offset	0.00 ... 10.00 V	5.00 V
<b>12.21.2</b>	PID Voltage isolated / global PSP2	Delay time	0.0 ... 600.0	0.5 sec.
<b>12.21.3</b>		Ramp time	0.0 ... 600.0	0.0 sec.
<b>12.21.4</b>		Dead zone	0.0 ... 50.0 %	1.0 %
<b>12.21.5</b>		Amplification (Kp)	0.01 ... 99.99	0.10
<b>12.21.6</b>		Integration time (Tn)	0.0 ... 999.9 sec.	0.5 sec.
<b>12.21.7</b>		Derivative time (Tv)	0.0 ... 99.9 sec.	0.0 sec.
<b>12.21.8</b>		Reset time (T1)	0.0 ... 99.9 sec.	0.0 sec.
<b>12.21.9</b>		Deviating from PSP1	0 (as PSP1) / 255 (deviating)	0
<b>12.21.10</b>		global / operating mode depended	0 (OM depended) / 255 (global)	255
<b>12.22.2</b>	PID Frequency isolated / global PSP2	Delay time	0.0 ... 600.0	0.5 sec.
<b>12.22.3</b>		Ramp time	0.0 ... 600.0	0.0 sec.
<b>12.22.4</b>		Dead zone	0.0 ... 50.0 %	0.1 %
<b>12.22.5</b>		Amplification (Kp)	0.01 ... 99.99	0.10
<b>12.22.6</b>		Integration time (Tn)	0.0 ... 999.9 sec.	0.5 sec.
<b>12.22.7</b>		Derivative time (Tv)	0.0 ... 99.9 sec.	0.0 sec.
<b>12.22.8</b>		Reset time (T1)	0.0 ... 99.9 sec.	0.0 sec.
<b>12.22.9</b>		Deviating from PSP1	0 (as PSP1) / 255 (deviating)	0
<b>12.22.10</b>		global / operating mode depended	0 (OM depended) / 255 (global)	255
<b>12.23.2</b>	PID Voltage SYN PSP2	Delay time	0.0 ... 600.0	0.5 sec.
<b>12.23.3</b>		Ramp time	0.0 ... 600.0	0.0 sec.
<b>12.23.4</b>		Dead zone	0.0 ... 50.0 %	1.0 %
<b>12.23.5</b>		Amplification (Kp)	0.01 ... 99.99	0.10
<b>12.23.6</b>		Integration time (Tn)	0.0 ... 999.9 sec.	0.5 sec.
<b>12.23.7</b>		Derivative time (Tv)	0.0 ... 99.9 sec.	0.0 sec.
<b>12.23.8</b>		Reset time (T1)	0.0 ... 99.9 sec.	0.0 sec.

Parameter	Description	Setting range	Default
<b>12.24.2</b>	PID Frequency SYN PSP2	Delay time	0.0 ... 600.0
<b>12.24.3</b>		Ramp time	0.0 ... 600.0
<b>12.24.4</b>		Dead zone	0.0 ... 50.0 %
<b>12.24.5</b>		Amplification (Kp)	0.01 ... 99.99
<b>12.24.6</b>		Integration time (Tn)	0.0 ... 999.9 sec.
<b>12.24.7</b>		Derivative time (Tv)	0.0 ... 99.9 sec.
<b>12.24.8</b>		Reset time (T1)	0.0 ... 99.9 sec.
<b>12.25.2</b>	PID Voltage Mains parallel PSP2	Delay time	0.0 ... 600.0
<b>12.25.3</b>		Ramp time	0.0 ... 600.0
<b>12.25.4</b>		Dead zone	0.0 ... 50.0 %
<b>12.25.5</b>		Amplification (Kp)	0.01 ... 99.99
<b>12.25.6</b>		Integration time (Tn)	0.0 ... 999.9 sec.
<b>12.25.7</b>		Derivative time (Tv)	0.0 ... 99.9 sec.
<b>12.25.8</b>		Reset time (T1)	0.0 ... 99.9 sec.
<b>12.26.2</b>	PID Frequency Mains parallel PSP2	Delay time	0.0 ... 600.0
<b>12.26.3</b>		Ramp time	0.0 ... 600.0
<b>12.26.4</b>		Dead zone	0.0 ... 50.0 %
<b>12.26.5</b>		Amplification (Kp)	0.01 ... 99.99
<b>12.26.6</b>		Integration time (Tn)	0.0 ... 999.9 sec.
<b>12.26.7</b>		Derivative time (Tv)	0.0 ... 99.9 sec.
<b>12.26.8</b>		Reset time (T1)	0.0 ... 99.9 sec.
<b>12.27.2</b>	IMP Voltage isolated / global PSP2	Release delay	0.0 ... 600.0
<b>12.27.3</b>		Modulation	0 (PWM) / 1 (PFM)
<b>12.27.4</b>		Dead zone	0.0 ... 50.0 %
<b>12.27.5</b>		Amplify (pulse / % / pulse / per.)	0.01 ... 99.99
<b>12.27.6</b>		Pulse duration / period duration	0.1 ... 999.9 sec.
<b>12.27.9</b>		Pulse duration / period duration	0 (as PSP1) / 255 (deviating)
<b>12.27.10</b>		Deviating from PSP1 global / operating mode depended	0 (OM depended) / 255 (global)
<b>12.28.2</b>	IMP Frequency isolated / global PSP2	Release delay	0.0 ... 600.0
<b>12.28.3</b>		Modulation	0 (PWM) / 1 (PFM)
<b>12.28.4</b>		Dead zone	0.0 ... 50.0 %
<b>12.28.5</b>		Amplify (pulse / % / pulse / per.)	0.01 ... 99.99
<b>12.28.6</b>		Pulse duration / period duration	0.1 ... 999.9 sec.
<b>12.28.9</b>		Pulse duration / period duration	0 (as PSP1) / 255 (deviating)
<b>12.28.10</b>		Deviating from PSP1 global / operating mode depended	0 (OM depended) / 255 (global)

Parameter	Description	Setting range	Default	
12.29.2 12.29.3 12.29.4 12.29.5 12.29.6	IMP Voltage SYN PSP2	Release delay Modulation Dead zone Amplify (pulse / % / pulse / per.) Pulse duration / period duration	0.0 ... 600.0 0 (PWM) / 1 (PFM) 0.0 ... 50.0 % 0.01 ... 99.99 0.1 ... 999.9 sec.	0.5 sec. 1 1.0 % 0.50 sec. 0.1 sec.
12.30.2 12.30.3 12.30.4 12.30.5 12.30.6	IMP Frequency SYN PSP2	Release delay Modulation Dead zone Amplify (pulse / % / pulse / per.) Pulse duration / period duration	0.0 ... 600.0 0 (PWM) / 1 (PFM) 0.0 ... 50.0 % 0.01 ... 99.99 0.1 ... 999.9 sec.	0.5 sec. 1 0.1 % 0.50 sec. 0.1 sec.
12.31.2 12.31.3 12.31.4 12.31.5 12.31.6	IMP Voltage Mains parallel PSP2	Release delay Modulation Dead zone Amplify (pulse / % / pulse / per.) Pulse duration / period duration	0.0 ... 600.0 0 (PWM) / 1 (PFM) 0.0 ... 50.0 % 0.01 ... 99.99 0.1 ... 999.9 sec.	0.5 sec. 1 1.0 % 0.50 sec. 0.1 sec.
12.32.2 12.32.3 12.32.4 12.32.5 12.32.6	IMP Frequency Mains parallel PSP2	Release delay Modulation Dead zone Amplify (pulse / % / pulse / per.) Pulse duration / period duration	0.0 ... 600.0 0 (PWM) / 1 (PFM) 0.0 ... 50.0 % 0.01 ... 99.99 0.1 ... 999.9 sec.	0.5 sec. 1 0.1 % 0.50 sec. 0.1 sec.
12.33.3 12.33.5 12.33.6 12.33.9 12.33.10	Electronic Potentiometer Voltage isolated / global PSP2	Ramp Swing Offset Deviating from PSP1 global / operating mode depended	0.1 ... 250.0 s 0.01 ... 10.00 V 0.00 ... 10.00 V 0 (as PSP1) / 255 (deviating) 0 (OM depended) / 255 (global)	10.0 s 5.00 V 5.00 V 0 255
12.34.3 12.34.5 12.34.6 12.34.9 12.34.10	Electronic Potentiometer Frequency isolated / global PSP2	Ramp Swing Offset Deviating from PSP1 global / operating mode depended	0.1 ... 250.0 s 0.01 ... 10.00 V 0.00 ... 10.00 V 0 (as PSP1) / 255 (deviating) 0 (OM depended) / 255 (global)	10,0 s 5.00 V 5.00 V 0 255

Parameter	Description	Setting range	Default
<b>12.35.3</b>	Electronic	Ramp	0.1 ... 250.0 s
<b>12.35.5</b>	Potentiometer	Swing	0.01 ... 10.00 V
<b>12.35.6</b>	Voltage SYN PSP2	Offset	0.00 ... 10.00 V
<b>12.36.3</b>	Electronic	Ramp	0.1 ... 250.0 s
<b>12.36.5</b>	Potentiometer	Swing	0.01 ... 10.00 V
<b>12.36.6</b>	Frequency SYN PSP2	Offset	0.00 ... 10.00 V
<b>12.37.3</b>	Electronic	Ramp	0.1 ... 250.0 s
<b>12.37.5</b>	Potentiometer	Swing	0.01 ... 10.00 V
<b>12.37.6</b>	Voltage Mains parallel PSP2	Offset	0.00 ... 10.00 V
<b>12.38.3</b>	Electronic	Ramp	0.1 ... 250.0 s
<b>12.38.5</b>	Potentiometer	Swing	0.01 ... 10.00 V
<b>12.38.6</b>	Frequency Mains parallel PSP2	Offset	0.00 ... 10.00 V
<b>12.40.2</b>	PID Voltage isolated / global PSP3	Delay time	0.0 ... 600.0
<b>12.40.3</b>		Ramp time	0.0 ... 600.0
<b>12.40.4</b>		Dead zone	0.0 ... 50.0 %
<b>12.40.5</b>		Amplification (Kp)	0.01 ... 99.99
<b>12.40.6</b>		Integration time (Tn)	0.0 ... 999.9 sec.
<b>12.40.7</b>		Derivative time (Tv)	0.0 ... 99.9 sec.
<b>12.40.8</b>		Reset time (T1)	0.0 ... 99.9 sec.
<b>12.40.9</b>		Deviating from PSP1	0 (as PSP1) / 255 (deviating)
<b>12.40.10</b>		global / operating mode depended	0 (OM depended) / 255 (global)
<b>12.41.2</b>		PID Frequency isolated / global PSP3	Delay time
<b>12.41.3</b>	Ramp time		0.0 ... 600.0
<b>12.41.4</b>	Dead zone		0.0 ... 50.0 %
<b>12.41.5</b>	Amplification (Kp)		0.01 ... 99.99
<b>12.41.6</b>	Integration time (Tn)		0.0 ... 999.9 sec.
<b>12.41.7</b>	Derivative time (Tv)		0.0 ... 99.9 sec.
<b>12.41.8</b>	Reset time (T1)		0.0 ... 99.9 sec.
<b>12.41.9</b>	Deviating from PSP1		0 (as PSP1) / 255 (deviating)
<b>12.41.10</b>	global / operating mode depended		0 (OM depended) / 255 (global)

Parameter	Description	Setting range	Default
12.42.2	PID Voltage SYN PSP3	Delay time	0.0 ... 600.0
12.42.3		Ramp time	0.0 ... 600.0
12.42.4		Dead zone	0.0 ... 50.0 %
12.42.5		Amplification (Kp)	0.01 ... 99.99
12.42.6		Integration time (Tn)	0.0 ... 999.9 sec.
12.42.7		Derivative time (Tv)	0.0 ... 99.9 sec.
12.42.8		Reset time (T1)	0.0 ... 99.9 sec.
12.43.2	PID Frequency SYN PSP3	Delay time	0.0 ... 600.0
12.43.3		Ramp time	0.0 ... 600.0
12.43.4		Dead zone	0.0 ... 50.0 %
12.43.5		Amplification (Kp)	0.01 ... 99.99
12.43.6		Integration time (Tn)	0.0 ... 999.9 sec.
12.43.7		Derivative time (Tv)	0.0 ... 99.9 sec.
12.43.8		Reset time (T1)	0.0 ... 99.9 sec.
12.44.2	PID Voltage Mains parallel PSP3	Delay time	0.0 ... 600.0
12.44.3		Ramp time	0.0 ... 600.0
12.44.4		Dead zone	0.0 ... 50.0 %
12.44.5		Amplification (Kp)	0.01 ... 99.99
12.44.6		Integration time (Tn)	0.0 ... 999.9 sec.
12.44.7		Derivative time (Tv)	0.0 ... 99.9 sec.
12.44.8		Reset time (T1)	0.0 ... 99.9 sec.
12.45.2	PID Frequency Mains parallel PSP3	Delay time	0.0 ... 600.0
12.45.3		Ramp time	0.0 ... 600.0
12.45.4		Dead zone	0.0 ... 50.0 %
12.45.5		Amplification (Kp)	0.01 ... 99.99
12.45.6		Integration time (Tn)	0.0 ... 999.9 sec.
12.45.7		Derivative time (Tv)	0.0 ... 99.9 sec.
12.45.8		Reset time (T1)	0.0 ... 99.9 sec.
12.46.2	IMP Voltage isolated / global PSP3	Release delay	0.0 ... 600.0
12.46.3		Modulation	0 (PWM) / 1 (PFM)
12.46.4		Dead zone	0.0 ... 50.0 %
12.46.5		Amplify (pulse / % /	0,01 ... 99.99
12.46.6		pulse / per.)	0.1 ... 999.9 sec.
12.46.9		Pulse duration /	0 (as PSP1) / 255 (deviating)
12.46.10		period duration	0 (OM depended) / 255
		Deviating from PSP1	(global)
		global / operating	
		mode depended	

Parameter	Description	Setting range	Default	
12.47.2 12.47.3 12.47.4 12.47.5 12.47.6 12.47.9 12.47.10	IMP Frequency isolated / global PSP3	Release delay Modulation Dead zone Amplify (pulse / % / pulse / per.) Pulse duration / period duration Deviating from PSP1 global / operating mode depended	0.0 ... 600.0 0 (PWM) / 1 (PFM) 0.0 ... 50.0 % 0,01 ... 99.99 0.1 ... 999.9 sec. 0 (as PSP1) / 255 (deviating) 0 (OM depended) / 255 255	0.5 sec. 1 0.1 % 0.5 sec. 0.1 sec. 0 255
12.48.2 12.48.3 12.48.4 12.48.5 12.48.6	IMP Voltage SYN PSP3	Release delay Modulation Dead zone Amplify (pulse / % / pulse / per.) Pulse duration / period duration	0.0 ... 600.0 0 (PWM) / 1 (PFM) 0.0 ... 50.0 % 0,01 ... 99.99 0.1 ... 999.9 sec.	0.5 sec. 1 1.0 % 0.50 sec. 0.1 sec.
12.49.2 12.49.3 12.49.4 12.49.5 12.49.6	IMP Frequency SYN PSP3	Release delay Modulation Dead zone Amplify (pulse / % / pulse / per.) Pulse duration / period duration	0.0 ... 600.0 0 (PWM) / 1 (PFM) 0.0 ... 50.0 % 0,01 ... 99.99 0.1 ... 999.9 sec.	0.5 sec. 1 0.1 % 0.50 sec. 0.1 sec.
12.50.2 12.50.3 12.50.4 12.50.5 12.50.6	IMP Voltage Mains parallel PSP3	Release delay Modulation Dead zone Amplify (pulse / % / pulse / per.) Pulse duration / period duration	0.0 ... 600.0 0 (PWM) / 1 (PFM) 0.0 ... 50.0 % 0,01 ... 99.99 0.1 ... 999.9 sec.	0.5 sec. 1 1.0 % 0.50 sec. 0.1 sec.
12.51.2 12.51.3 12.51.4 12.51.5 12.51.6	IMP Frequency Mains parallel PSP3	Release delay Modulation Dead zone Amplify (pulse / % / pulse / per.) Pulse duration / period duration	0.0 ... 600.0 0 (PWM) / 1 (PFM) 0.0 ... 50.0 % 0,01 ... 99.99 0.1 ... 999.9 sec.	0.5 sec. 1 0.1 % 0.50 sec. 0.1 sec.



Parameter	Description	Description	Setting range	Default
<b>12.52.3</b> <b>12.52.5</b> <b>12.52.6</b> <b>12.52.9</b> <b>12.52.10</b>	Electronic Potentiometer Voltage isolated / global PSP3	Ramp Swing Offset Deviating from PSP1 global / operating mode depended	0.1 ... 250.0 s 0.01 ... 10.00 V 0.00 ... 10.00 V 0 (as PSP1) / 255 (deviating) 0 (OM depended) / 255 (global)	10.0 s 5.00 V 5.00 V 0 255
<b>12.53.3</b> <b>12.53.5</b> <b>12.53.6</b> <b>12.53.9</b> <b>12.53.10</b>	Electronic Potentiometer Frequency isolated / global PSP3	Ramp Swing Offset Deviating from PSP1 global / operating mode depended	0.1 ... 250.0 s 0.01 ... 10.00 V 0.00 ... 10.00 V 0 (as PSP1) / 255 (deviating) 0 (OM depended) / 255 (global)	10.0 s 5.00 V 5.00 V 0 255
<b>12.54.3</b> <b>12.54.5</b> <b>12.54.6</b>	Electronic Potentiometer Voltage SYN PSP3	Ramp Swing Offset	0.1 ... 250.0 s 0.01 ... 10.00 V 0.00 ... 10.00 V	10.0 s 5.00 V 5.00 V
<b>12.55.3</b> <b>12.55.5</b> <b>12.55.6</b>	Electronic Potentiometer Frequency SYN PSP3	Ramp Swing Offset	0.1 ... 250.0 s 0.01 ... 10.00 V 0.00 ... 10.00 V	10.0 s 5.00 V 5.00 V
<b>12.56.3</b> <b>12.56.5</b> <b>12.56.6</b>	Electronic Potentiometer Voltage Mains parallel PSP3	Ramp Swing Offset	0.1 ... 250.0 s 0.01 ... 10.00 V 0.00 ... 10.00 V	10.0 s 5.00 V 5.00 V
<b>12.57.3</b> <b>12.57.5</b> <b>12.57.6</b>	Electronic Potentiometer Frequency Mains parallel PSP3	Ramp Swing Offset	0.1 ... 250.0 s 0.01 ... 10.00 V 0.00 ... 10.00 V	10.0 s 5.00 V 5.00 V
<b>12.59.2</b> <b>12.59.3</b> <b>12.59.4</b> <b>12.59.5</b> <b>12.59.6</b> <b>12.59.7</b> <b>12.59.8</b> <b>12.59.9</b> <b>12.59.10</b>	PID Voltage isolated / global PSP4	Delay time Ramp time Dead zone Amplification (Kp) Integration time (Tn) Derivative time (Tv) Reset time (T1) Deviating from PSP1 global / operating mode depended	0.0 ... 600.0 0.0 ... 600.0 0.0 ... 50.0 % 0.01 ... 99.99 0.0 ... 999.9 sec. 0.0 ... 99.9 sec. 0.0 ... 99.9 sec. 0 (as PSP1) / 255 (deviating) 0 (OM depended) / 255 (global)	0.5 sec. 0.0 sec. 1.0 % 0.10 0.5 sec. 0.0 sec. 0.0 sec. 0 255



Parameter	Description	Setting range	Default
12.60.2	PID Frequency isolated / global PSP4	Delay time	0.0 ... 600.0
12.60.3		Ramp time	0.0 ... 600.0
12.60.4		Dead zone	0.0 ... 50.0 %
12.60.5		Amplification (Kp)	0.01 ... 99.99
12.60.6		Integration time (Tn)	0.0 ... 999.9 sec.
12.60.7		Derivative time (Tv)	0.0 ... 99.9 sec.
12.60.8		Reset time (T1)	0.0 ... 99.9 sec.
12.60.9		Deviating from PSP1	0 (as PSP1) / 255 (deviating)
12.60.10		global / operating mode depended	0 (OM depended) / 255 (global)
12.61.2		PID Voltage SYN PSP4	Delay time
12.61.3	Ramp time		0.0 ... 600.0
12.61.4	Dead zone		0.0 ... 50.0 %
12.61.5	Amplification (Kp)		0.01 ... 99.99
12.61.6	Integration time (Tn)		0.0 ... 999.9 sec.
12.61.7	Derivative time (Tv)		0.0 ... 99.9 sec.
12.61.8	Reset time (T1)		0.0 ... 99.9 sec.
12.62.2	PID Frequency SYN PSP4		Delay time
12.62.3		Ramp time	0.0 ... 600.0
12.62.4		Dead zone	0.0 ... 50.0 %
12.62.5		Amplification (Kp)	0.01 ... 99.99
12.62.6		Integration time (Tn)	0.0 ... 999.9 sec.
12.62.7		Derivative time (Tv)	0.0 ... 99.9 sec.
12.62.8		Reset time (T1)	0.0 ... 99.9 sec.
12.63.2		PID Voltage Mains parallel PSP4	Delay time
12.63.3	Ramp time		0.0 ... 600.0
12.63.4	Dead zone		0.0 ... 50.0 %
12.63.5	Amplification (Kp)		0.01 ... 99.99
12.63.6	Integration time (Tn)		0.0 ... 999.9 sec.
12.63.7	Derivative time (Tv)		0.0 ... 99.9 sec.
12.63.8	Reset time (T1)		0.0 ... 99.9 sec.
12.64.2	PID Frequency Mains parallel PSP4		Delay time
12.64.3		Ramp time	0.0 ... 600.0
12.64.4		Dead zone	0.0 ... 50.0 %
12.64.5		Amplification (Kp)	0.01 ... 99.99
12.64.6		Integration time (Tn)	0.0 ... 999.9 sec.
12.64.7		Derivative time (Tv)	0.0 ... 99.9 sec.
12.64.8		Reset time (T1)	0.0 ... 99.9 sec.

Parameter	Description	Setting range	Default	
<b>12.65.2</b> <b>12.65.3</b> <b>12.65.4</b> <b>12.65.5</b> <b>12.65.6</b> <b>12.65.9</b> <b>12.65.10</b>	IMP Voltage Mains parallel PSP4	Release delay Modulation Dead zone Amplify (pulse / % / pulse / per.) Pulse duration / period duration Deviating from PSP1 global / operating mode depended	0.0 ... 600.0 0 (PWM) / 1 (PFM) 0.0 ... 50.0 % 0.01 ... 99.99 0.1 ... 999.9 sec. 0 (as PSP1) / 255 (deviating) 0 (OM depended) / 255 (global)	0.5 sec. 1 1.0 % 0.50 sec. 0.1 sec. 0 255
<b>12.66.2</b> <b>12.66.3</b> <b>12.66.4</b> <b>12.66.5</b> <b>12.66.6</b> <b>12.66.9</b> <b>12.66.10</b>	IMP Frequency Mains parallel PSP4	Release delay Modulation Dead zone Amplify (pulse / % / pulse / per.) Pulse duration / period duration Deviating from PSP1 global / operating mode depended	0.0 ... 600.0 0 (PWM) / 1 (PFM) 0.0 ... 50.0 % 0.01 ... 99.99 0.1 ... 999.9 sec. 0 (as PSP1) / 255 (deviating) 0 (OM depended) / 255 (global)	0.5 sec. 1 0.1 % 0.50 sec. 0.1 sec. 0 255
<b>12.67.2</b> <b>12.67.3</b> <b>12.67.4</b> <b>12.67.5</b> <b>12.67.6</b>	IMP Voltage SYN PSP4	Release delay Modulation Dead zone Amplify (pulse / % / pulse / per.) Pulse duration / period duration	0.0 ... 600.0 0 (PWM) / 1 (PFM) 0.0 ... 50.0 % 0.01 ... 99.99 0.1 ... 999.9 sec	0.5 sec. 1 1.0 % 0.50 sec. 0.1 sec.
<b>12.68.2</b> <b>12.68.3</b> <b>12.68.4</b> <b>12.68.5</b> <b>12.68.6</b>	IMP Frequency SYN PSP4	Release delay Modulation Dead zone Amplify (pulse / % / pulse / per.) Pulse duration / period duration	0.0 ... 600.0 0 (PWM) / 1 (PFM) 0.0 ... 50.0 % 0.01 ... 99.99 0.1 ... 999.9 sec	0.5 sec. 1 0.1 % 0.50 sec. 0.1 sec.
<b>12.69.2</b> <b>12.69.3</b> <b>12.69.4</b> <b>12.69.5</b> <b>12.69.6</b>	IMP Voltage Mains parallel PSP4	Release delay Modulation Dead zone Amplify (pulse / % / pulse / per.) Pulse duration / period duration	0.0 ... 600.0 0 (PWM) / 1 (PFM) 0.0 ... 50.0 % 0.01 ... 99.99 0.1 ... 999.9 sec	0.5 sec. 1 1.0 % 0.50 sec. 0.1 sec.

Parameter	Description	Setting range	Default	
<b>12.70.2</b> <b>12.70.3</b> <b>12.70.4</b> <b>12.70.5</b> <b>12.70.6</b>	IMP Frequency Mains parallel PSP4	Release delay Modulation Dead zone Amplify (pulse / % / pulse / per.) Pulse duration / period duration	0.0 ... 600.0 0 (PWM) / 1 (PFM) 0.0 ... 50.0 % 0.01 ... 99.99 0.1 ... 999.9 sec	0,5 sec. 1 0.1 % 0.50 sec. 0.1 sec.
<b>12.71.3</b> <b>12.71.5</b> <b>12.71.6</b> <b>12.71.9</b> <b>12.71.10</b>	Electronic Potentiometer Voltage isolated / global PSP4	Ramp Swing Offset Deviating from PSP1 global / operating mode depended	0.1 ... 250.0 s 0.01 ... 10.00 V 0.00 ... 10.00 V 0 (as PSP1) / 255 (deviating) 0 (OM depended) / 255 (global)	10.0 s 5.00 V 5.00 V 0 255
<b>12.72.3</b> <b>12.72.5</b> <b>12.72.6</b> <b>12.72.9</b> <b>12.72.10</b>	Electronic Potentiometer Frequency isolated / global PSP4	Ramp Swing Offset Deviating from PSP1 global / operating mode depended	0.1 ... 250.0 s 0.01 ... 10.00 V 0.00 ... 10.00 V 0 (as PSP1) / 255 (deviating) 0 (OM depended) / 255 (global)	10.0 s 5.00 V 5.00 V 0 255
<b>12.73.3</b> <b>12.73.5</b> <b>12.73.6</b>	Electronic Potentiometer Voltage SYN PSP4	Ramp Swing Offset	0.1 ... 250.0 s 0.01 ... 10.00 V 0.00 ... 10.00 V	10.0 s 5.00 V 5.00 V
<b>12.74.3</b> <b>12.74.5</b> <b>12.74.6</b>	Electronic Potentiometer Frequency SYN PSP4	Ramp Swing Offset	0.1 ... 250.0 s 0.01 ... 10.00 V 0.00 ... 10.00 V	10.0 s 5.00 V 5.00 V
<b>12.75.3</b> <b>12.75.5</b> <b>12.75.6</b>	Electronic Potentiometer Voltage Mains parallel PSP4	Ramp Swing Offset	0.1 ... 250.0 s 0.01 ... 10.00 V 0.00 ... 10.00 V	10.0 s 5.00 V 5.00 V
<b>12.76.3</b> <b>12.76.5</b> <b>12.76.6</b>	Electronic Potentiometer Frequency Mains parallel PSP4	Ramp Swing Offset	0.1 ... 250.0 s 0.01 ... 10.00 V 0.00 ... 10.00 V	10.0 s 5.00 V 5.00 V

**Alfred Kuhse GmbH**  
An der Kleinbahn 39  
D-21423 Winsen | Germany  
Fon +49. (0)4171.798.0  
Fax +49. (0)4171.798.117  
[www.kuhse.de](http://www.kuhse.de)